



HEBEL PRODUCT GUIDE



HOW TO ORDER

Hebel Sales & Customer Service

Phone: 1300 302 529

Fax: 02 4340 3300

Online

Order online at csrconnect.com.au

HEBEL GENERAL ENQUIRIES

Phone: 1300 369 448

www.hebel.com.au

TERMS AND CONDITIONS

Products described in this document must be used in accordance with the appropriate technical resource or as otherwise advised in writing by CSR Hebel. The latest editions of technical resources are available at www.hebel.com.au

CONTENTS

Facts about Hebel	3
Where is Hebel used	4
Benefits of Hebel	5
PowerBlock+ (External & Internal Walls, Bathroom Hobs & DIY)	6
PowerPanel ^{XL} (External & Zero Boundary Walls)	9
PowerPanel ^{XL} (Intertenancy / Party Walls)	12
PowerPanel ⁵⁰ (External Walls)	14
PowerPanel ⁵⁰ (Intertenancy / Party and Dual Zero Boundary Walls)	17
PowerFloor	20
PowerFence	22
PowerPanel (Tongue & Groove)	25
PowerPanel (Square Edge)	29
PowerPanel+ (Caged Tongue & Groove)	32
PowerFloor+	34
SoundBarrier	36
PowerShield	38
Glossary	40
Accessories	42



CSR Connect has been designed especially for today's busy tradesperson giving easy and instant access to CSR when and where you need it.

Place orders, look up products and prices, make payments, download account information and more via desktop, mobile or tablet. Plus it's at no cost to customers.

Registration is FREE and it only takes 60 seconds to get started. If you are new to CSR products or want to give feedback or have a query about CSR Connect, please get in touch with our friendly CSR Connect team via phone, email or live chat.

help@csr.com.au
 1800 9090 439 (AU)
 0800 277 266 (NZ)
 Live chat csr.connect.com.au

FACTS ABOUT HEBEL

1. Hebel is the name of the autoclaved aerated concrete (AAC) developed, manufactured and marketed by CSR Building Products (CSR) as the exclusive licensee of Xella for Australia and New Zealand.
2. Hebel is also the name used of the business unit of CSR responsible for Hebel products and systems – also referred to as 'CSR Hebel'.
3. CSR is Australia's only manufacturer of AAC with 25 years' experience delivering quality Hebel products.
4. Hebel AAC is a high performing building material that is strong, solid, lightweight compared to other masonry products, eco-friendly, non-combustible, fire and termite resistant with good acoustic performance values.
5. Produced in block and panel form, Hebel AAC panels are reinforced with corrosion protected steel mesh for strength, robustness and durability.
6. Hebel products and systems have been rigorously tested for performance and are well proven in the market as fast and efficient ways to construct quality buildings and structures such as walls and floors, loadbearing and non-loadbearing.
7. CSR Hebel provides quality technical support to assist in the design and construction of projects as needed.
8. Applications for Hebel products extend right across residential, commercial, industrial, civil and utilities construction with a wide range of product types and sizes available as stock, made-to-length or custom made.
9. All Hebel AAC reinforced panel products are rigorously tested to ensure they comply with the Australian Standard for Reinforced Autoclaved Aerated Concrete (AAC), AS 5146. AS 5146 was referenced in the Building Code of Australia in May 2016 giving the following AAC construction systems Deemed-to-Satisfy (DTS) status:
 - Houses and Low Rise 75mm AAC External Walls
 - Low Rise 75mm AAC Intertency / Party Walls
 - 75mm AAC Floors
 - 75mm AAC High Rise Façade Walls
 - 150mm-300mm AAC Floors

WHAT IS AAC?

Autoclaved aerated concrete (AAC) is a solid yet lightweight building material that's widely used in construction throughout the world. The technology to manufacture AAC was developed in Scandinavia over 70 years ago.

In the AAC manufacturing process water and readily available dry ingredients – sand, lime and cement – are mixed with an expansion agent to form a semi-liquid mix called slurry which is poured into a mould. If panels are being produced then steel mesh reinforcement will be appropriately placed in the mould before the slurry pour.

Chemical reactions occur between the ingredients causing hydrogen to form, which in turn causes the slurry to rise. This is called the pre-curing stage. The hydrogen gas then dissipates leaving extremely small, finely dispersed air spaces. This is the essence of why AAC is much lighter than traditional concrete, yet strong and solid with excellent thermal properties.

The solid but still soft mix is separated from the mould and cut to form the right-sized blocks or panels for the batch. Any waste is recycled. The manufacturing process doesn't stop there however. The uncured AAC panels are 'baked' under elevated heat and steam. The blocks and panels are ready when they're hardened or cured.

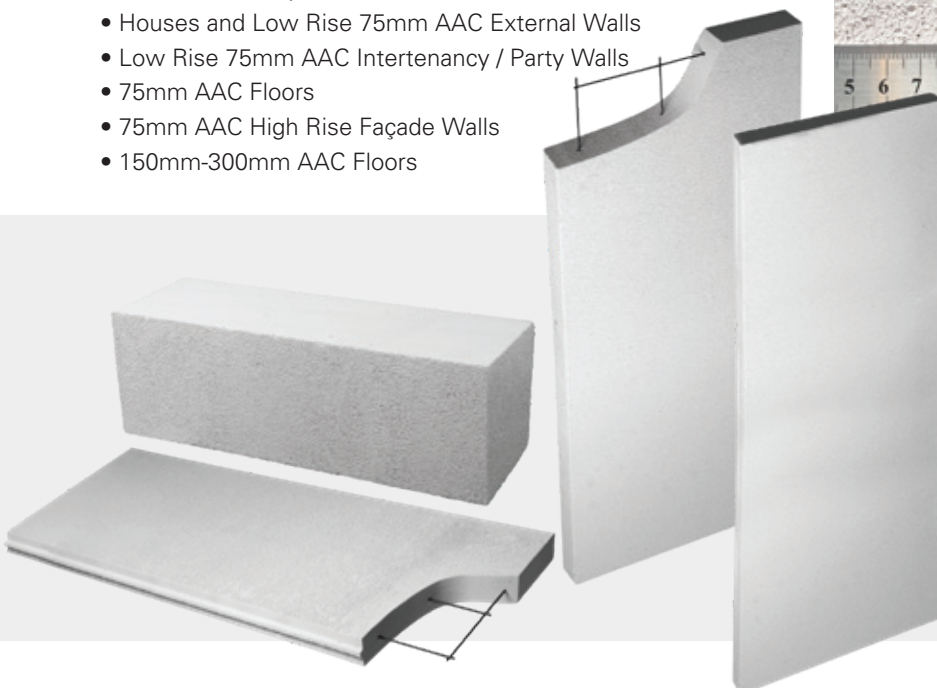
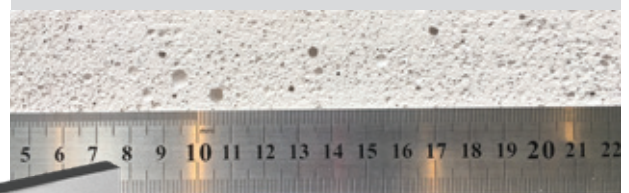

Strong and solid, Hebel panels contain steel reinforcement for added strength with an anti-corrosion layer on the steel for maximum durability.

Where Hebel is used?



	HOUSES	DIY	MULTI-RESIDENTIAL	APARTMENTS	COMMERCIAL & INDUSTRIAL	CIVIL & UTILITIES
PowerPanel ^{XL}	<ul style="list-style-type: none"> External walls 		<ul style="list-style-type: none"> External walls Boundary walls Intertenancy and Party walls 			
PowerPanel ⁵⁰	<ul style="list-style-type: none"> External walls 		<ul style="list-style-type: none"> External walls Intertenancy / Party walls Dual Zero Boundary walls 			
PowerBlock+	<ul style="list-style-type: none"> External walls (min. 250mm thick blocks) Interior walls (100-150mm blocks) Bath Hobs Shower Hobs 	<ul style="list-style-type: none"> BBQs Letterboxes 			<ul style="list-style-type: none"> Internal walls Hygiene walls 	
PowerFence	<ul style="list-style-type: none"> Fencing 	<ul style="list-style-type: none"> Fencing 				
PowerFloor	<ul style="list-style-type: none"> Flooring 	<ul style="list-style-type: none"> Flooring (esp.decking) 	<ul style="list-style-type: none"> Flooring 			
PowerPanel				<ul style="list-style-type: none"> Intertenancy walls Corridor walls Shaft walls Service walls Facades Balcony Blades 	<ul style="list-style-type: none"> Intertenancy walls Corridor walls Shaft walls Service walls Facades Balcony Blades 	
PowerPanel+					<ul style="list-style-type: none"> External walls Internal walls Fire tunnels 	<ul style="list-style-type: none"> Fire walls Acoustic/fire walls
PowerFloor+				<ul style="list-style-type: none"> Flooring 	<ul style="list-style-type: none"> Flooring 	
PowerShield						<ul style="list-style-type: none"> Fire walls Acoustic/fire walls
SoundBarrier						<ul style="list-style-type: none"> Sound barriers (noise walls)

Benefits of Hebel



STRONG AND SOLID

Hebel panels are high-performance products containing steel reinforcement for added strength with an anti-corrosion layer on the steel for maximum durability.



QUALITY AND SPEED

Building with Hebel can mean faster construction times, without sacrificing on quality. One standard Hebel panel is the equivalent of 75 traditional bricks, which means a 150m² home can go up as quickly as within 3 days when installed by experienced Hebel installers. A high quality building material, Hebel provides a great solution in terms of speed and ease of construction which is why it is increasingly becoming the builder's choice.



ENERGY EFFICIENT

Hebel panels perform well thermally, helping to keep your house cool from the heat in summer, and keeping it warm and cosy in winter. That means less reliance on heating and cooling, and can lead to savings on energy costs.



ECO-FRIENDLY

Hebel is an environmentally friendly choice of building material, treading lightly on this planet. Manufactured in Australia, Hebel is made using readily available raw materials. Waste generated in the manufacturing process is recycled, even down to the steam that's produced.



NOISE REDUCTION

A Hebel home is a quiet one because it reduces noise transmission. Compared to polystyrene and many fibre cement substrates, the use of Hebel for external walls reduces noise from external sources like traffic, meaning more peace and quiet. And when used for upper floors, can reduce sound transference between levels as well.



FIRE RESISTANT

Hebel is renowned for its fire resistant properties, and is a non-combustible building material. Hebel systems have been tested by the CSIRO and are proven to achieve Fire Resistance Levels (FRLs) of 60 minutes through to 240 minutes, and meet or exceed the requirements for all six Bushfire Attack Level (BAL) categories. This makes it an ideal choice in bushfire zones.



PROVEN

CSR Hebel is the only manufacturer of AAC in Australia. With over 25 years of experience in developing, testing and producing AAC you can be assured you're getting high quality products and systems and unmatched technical expertise with Hebel.

PowerBlock+



EXTERNAL & INTERNAL WALLS, BATHROOM HOBBS & DIY

- HOUSES
- MULTI-RESIDENTIAL
- COMMERCIAL & INDUSTRIAL
- DIY

THE IDEAL ALTERNATIVE TO DOUBLE BRICK DELIVERING SUPERIOR THERMAL PERFORMANCE.

APPLICATIONS

HOUSES & MULTI-RESIDENTIAL

External walls

See system

- solid masonry loadbearing walls (min. 250mm thick blocks) up to 2 storeys*
- ideal alternative to double brick with 1½ times better thermal resistance
- easy to work with using standard tools including routing and shaping of blocks
- up to a 4 hour fire rating**

Internal walls

- solid masonry non-loadbearing walls (min. 100mm thick blocks)
- ideal alternative to other masonry products such as brick and pre-fabricated concrete

Bathroom hobs

- ideal for baths, showers and spas
- easy to cut, glue, assemble, level and shape in confined spaces
- provides solid substrate for the direct laying of wall and floor tiles

COMMERCIAL & INDUSTRIAL

Internal walls

- suitable for food areas in retail areas and hospitals as a solid masonry system to deter vermin
- can be used with PowerPanel+ system to achieve infill for separating walls
- ideal for fire rated walls separating tenancies
- easy to cut, glue, assemble, level and shape

DIY

BBQs

Letterboxes

- fast and easy to work with using standard tools including routing and shaping of blocks

*PowerBlock+ can be used in conjunction with PowerFloor+ for load bearing second storey solid floor.

** Refer to Hebel Technical Manual Part 2.

HOUSES AND MULTI-RESIDENTIAL - POWERBLOCK+ EXTERNAL WALL SYSTEM

Hebel PowerBlocks are laid in the same way as traditional masonry block using Hebel Adhesive between the blocks delivering a strong solid construction.

Fire rating	Acoustic	Thermal	Wall Thickness
up to 240/240/240	Rw + Ctr 35 to 42 (100 - 250mm thick)	R2.04 to R4.19	256mm to 356mm

Our System Specification Finder helps you find the best system for your next project.

Visit www.hebel.com.au/specification-tool

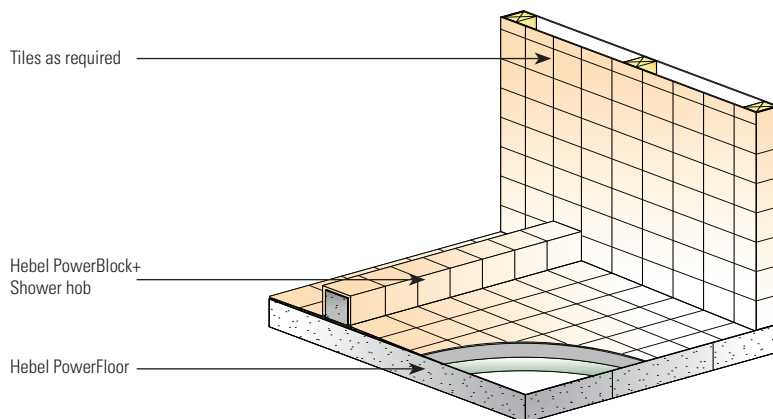
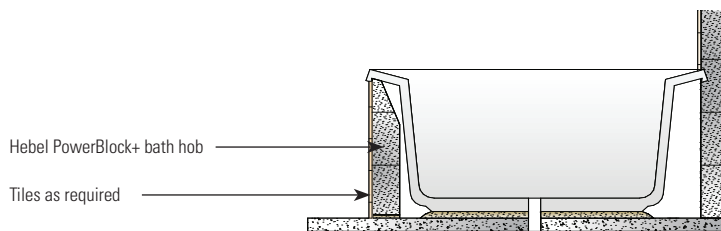
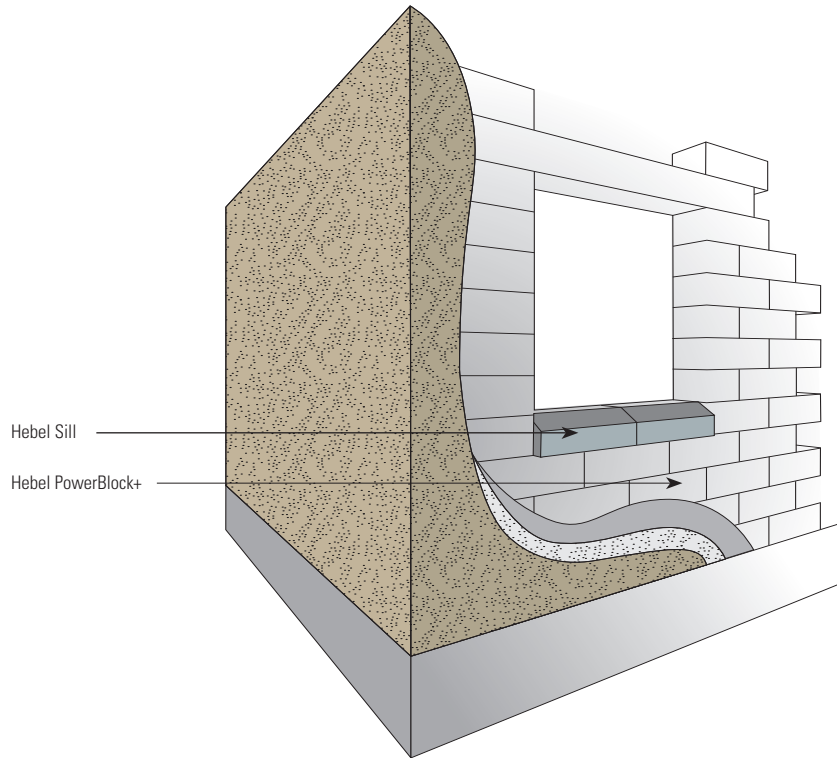

PRODUCT SIZES

Code	Length	Width	Thick	Description	Main Application	UoM	Order Unit	Quantity / Unit	Weight / Pallet
Hebel Blocks									
126611	600	200	50	PowerBlock+ 600 x 200 x 50	Close ring beams, capping	Each	Pallet	200	940
126612	600	200	75	PowerBlock+ 600 x 200 x 75	Hobs & DIY	Each	Pallet	130	910
126613	600	200	100	PowerBlock+ 600 x 200 x 100	Internal wall for solid masonry homes	Each	Pallet	100	936
126614	600	400	100	PowerBlock+ 600 x 400 x 100	Internal wall for solid masonry homes	Each	Pallet	50	936
126615	600	200	125	PowerBlock+ 600 x 200 x 125	Internal wall for solid masonry homes	Each	Pallet	80	936
126616	600	200	150	PowerBlock+ 600 x 200 x 150	External wall for solid masonry homes	Each	Pallet	60	842
126617	600	200	200	PowerBlock+ 600 x 200 x 200	External wall for solid masonry homes	Each	Pallet	50	935
126618	600	200	250	PowerBlock+ 600 x 200 x 250	External wall for solid masonry homes	Each	Pallet	40	850
126619	600	200	300	PowerBlock+ 600 x 200 x 300	External wall for solid masonry homes	Each	Pallet	30	842
22052	1200	300	300	Custom PowerBlock+ 300 x 1200 x 300*	Hobby & decoration	Each	Pallet	20	1360
Hebel Sills									
22036	600	200	50	Hebel Sill 50mm - Pack	Window sills	Each	Pack	6	145
22034	600	200	100	Hebel Sill 100mm - Pack	Window sills	Each	Pack	3	72

Note: Weight may vary due to moisture content.

* Made to order - allow 2 weeks lead time.

ACCESSORIES

Code	Description	Main Application	UoM	Order Unit	Quantity / Unit
Adhesives and Coatings					
21933	Hebel Adhesive	All systems	Bag	20kg Bag	1
21935	Hebel Mortar	All systems	Bag	20kg Bag	1
21949	Hebel Patch	All systems	Bag	10kg Bag	1
111161	Hebel Base Sealer 5L	Waterproofing for residential	Each	Each	1
Hand Tools					
21928	Trowel 75mm	All systems	Each	Pallet	1
21892	Levelling Plane	Levelling Hebel blocks	Each	Pallet	1
21912	Sanding Float	All systems	Each	Pack	1

PowerPanel^{XL}



FOR QUALITY SOLID EXTERNAL WALLS WITH A RENDERED FINISH. HIGH THERMAL AND FIRE RESISTANCE PROPERTIES.

EXTERNAL & ZERO BOUNDARY WALLS

- HOUSES
- LOW RISE MULTI-RESIDENTIAL

APPLICATIONS

HOUSES

External walls
See system

- delivers quality solid walls finished with a coating system
- high thermal performance – PowerPanel^{XL} has almost 3 times more resistance than a standard brick
- fast to construct - one standard Hebel panel is the equivalent of 75 traditional bricks, which means Hebel external walls 150m² home can go up as quickly as within 3 days when installed by experienced Hebel installers
- good acoustic performance
- patterns can be machined or routed into the panels to produce an individual, attractive finish
- system meets or exceeds all six Bushfire Attack Level (BAL) categories.

MULTI-RESIDENTIAL

Zero Boundary walls

- quality system that's fast to install
- cost efficient – can reduce scaffolding, minimised wastage
- patterns can be machined or routed into the panels to produce an individual, attractive finish

POWERPANEL^{XL} EXTERNAL WALL SYSTEM

The PowerPanel^{XL} system consists of 75mm thick, steel-reinforced AAC panels, vertically secured to the structural frame via horizontal perforated top hat sections. The wall is then rendered with a recommended coating system – providing a faster way of constructing external facades for residential builds.

FRL	Acoustic	Thermal	Wall Thickness
up to 180/180/180*	Rw + Ctr 35 to 39**	R1.61 to R3.57	179mm to 210mm

Our System Specification Finder helps you find the best system for your next project.

Visit www.hebel.com.au/specification-tool

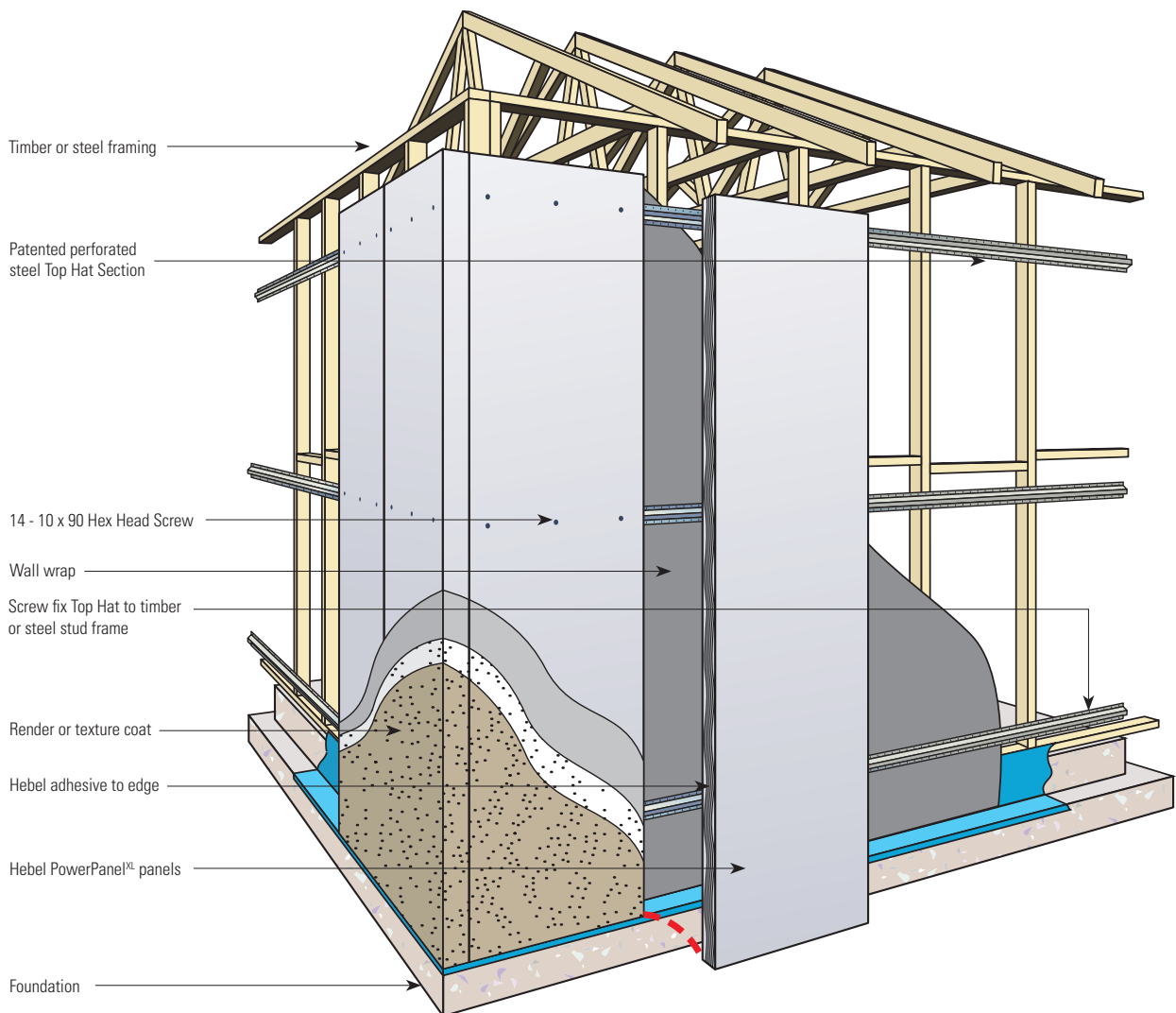

Note: Hebel Base Sealer should be applied in cases where panels are embedded below ground.

* The Hebel PowerPanel^{XL} external wall system achieves a FRL of 180/180/180 when subjected to an external fire source.

** The Acoustic value is based on a 210mm wall thickness. Refer to PowerPanel^{XL} external wall system design and installation guide for wall system configurations.

PRODUCT SIZES

Code	Length	Width	Thick	Description	UoM	Order Unit	Quantity / Unit	Weight / Pallet
PowerPanel - Standard Range 75								
21866	1200	600	75	Powerpanel 1200 x 600 x 75 SQ1M0	m2	Pack	10	390
118891	1800	600	75	Powerpanel 1800 x 600 x 75 SQ1M0	m2	Pack	10	580
PowerPanel^{XL} - Standard Range 75								
118014	2400	600	75	PowerPanel ^{XL} 2400 x 600 x 75 SQ1M0	m2	Pack	10	605
118015	2550	600	75	PowerPanel ^{XL} 2550 x 600 x 75 SQ1M0	m2	Pack	10	643
118016	2700	600	75	PowerPanel ^{XL} 2700 x 600 x 75 SQ1M0	m2	Pack	10	680
118017	2800	600	75	PowerPanel ^{XL} 2800 x 600 x 75 SQ1M0	m2	Pack	10	710
118019	2850	600	75	PowerPanel ^{XL} 2850 x 600 x 75 SQ1M0	m2	Pack	10	718
118020	3000	600	75	PowerPanel ^{XL} 3000 x 600 x 75 SQ1M0	m2	Pack	10	756
126504	3300	600	75	PowerPanel ^{XL} 3300 x 600 x 75 SQ1M0	m2	Pack	10	830
PowerPanel^{XL} - Made to Length in 5mm increments								
MTL 31	2400 to 3300	600	75	Made to Length PowerPanel ^{XL} 1M	m2	Each	10	-

SQ = Square Edge, 1M = Single Mesh, 0 = No Bevel.

Notes:

1. All Made to Length panels are: Made to Confirmed Order Only – Minimum Quants Apply – Lead Times Apply.
2. Weight may vary due to moisture content.

ACCESSORIES

Code	Description	Main Application	UoM	Order Unit	Quantity / Unit
Top Hats					
21909	Perforated TopHat 24mm x 4.8m x 0.42mm BMT	Attaching PowerPanel ^{XL} to frame	Each	Each	1
105536	Perforated TopHat 35mm x 4.8m x 0.55mm BMT	Attaching PowerPanel ^{XL} to frame	Each	Each	1
168890	Perforated TopHat 45mm x 4.8m x 0.42mm BMT	Attaching PowerPanel ^{XL} to frame	Each	Each	1
24092	TopHat 75mm x 4.8m x 0.70mm BMT	Attaching PowerPanel ^{XL} to frame	Each	Each	1
General Purpose Screws					
21906	Screw 10-16 x 16mm Hex Head Tekes	Fix TopHat to steel stud frame	Box	Box	1000
106882	Screw 12-11 x 35mm Hex Head Type 17	Fix TopHat to timber frame	Box	Box	500
21900	Screw 14-10 x 65mm Hex Head Type 17	Int. fix PowerPanel to TopHat	Box	Box	500
125747	Screw 14-10 x 90mm Hex Head Type 17	Ext. fix PowerPanel to TopHat	Box	Box	250
44174	Screw 14-10 x 150mm Hex Head Type 17	Screw panels together at corners	Box	Box	250
Residential Accessories					
21957	Slotted Angle 75mm x 50mm x 2.7m x 1.2mm BMT	Head support angle	Each	Each	1
165258	Aluminum Render Bead 3m x 70mm x .8mm	For horizontal control joints	Each	Each	1
110203	Hebel Direct Fixing Clip	Base support for PowerPanel	Each	Each	1
Adhesives and Coatings					
21933	Hebel Adhesive	All systems	Bag	20kg Bag	1
21935	Hebel Mortar	All systems	Bag	20kg Bag	1
21949	Hebel Patch	All systems	Bag	10kg Bag	1
25594	Hebel Anti - Corrosion Paint 500ml	Used to coat exposed reo	Each	Each	1
111161	Hebel Base Sealer 5L	Waterproofing for residential	Each	Each	1
Hand Tools					
21901	PowerPanel Lifters 16mm	Handling system for PowerPanel	Pair	Pair	1
107687	Panel Scissor Lifter 75mm	Panel lifter	Each	Each	1
119426	Panel Separator Kit	For all systems	Each	Each	1
162645	2 Wheel Panel Mover	Handling system for PowerPanel	Each	Each	1
130324	Installer PowerPanel Trolley	Handling system for PowerPanel	Each	Each	1

PowerPanel^{XL}



FOR A SOLID WALL SOLUTION THAT'S COST EFFECTIVE, FAST TO CONSTRUCT AND EASY TO ACHIEVE NCC FIRE AND ACOUSTIC RATING COMPLIANCE.

INTERTENANCY / PARTY WALLS
 ■ LOW RISE MULTI-RESIDENTIAL

APPLICATIONS

LOW RISE MULTI-RESIDENTIAL USING POWERPANEL^{XL} 75MM PANEL THICKNESS

Intertency / party walls

- fast and easy construction – services installation simplified
- easy to achieve NCC fire rating and acoustic rating compliance
- not affected by wet weather during installation
- Hebel Hoist enables faster, safer, more efficient construction – all frames and roof structures finished before panel installation

POWERPANEL^{XL} INTERTENANCY / PARTY WALL SYSTEM

Construction of the non-load bearing PowerPanel^{XL} wall leaf in the system is achieved by installing the Hebel panels vertically and securing between the structural steel or timber framing. An aluminium bracket provides discontinuous construction as required by the NCC.

FRL	Acoustic	Wall Thickness
90/90/90 (loadbearing stud frame)	Rw + Ctr 34 - 58	273 - 321mm* Discontinuous construction
-/90/90 (non-loadbearing stud frame)		

*Depending on stud and cavity selection

Our System Specification Finder helps you find the best system for your next project.

Visit www.hebel.com.au/specification-tool

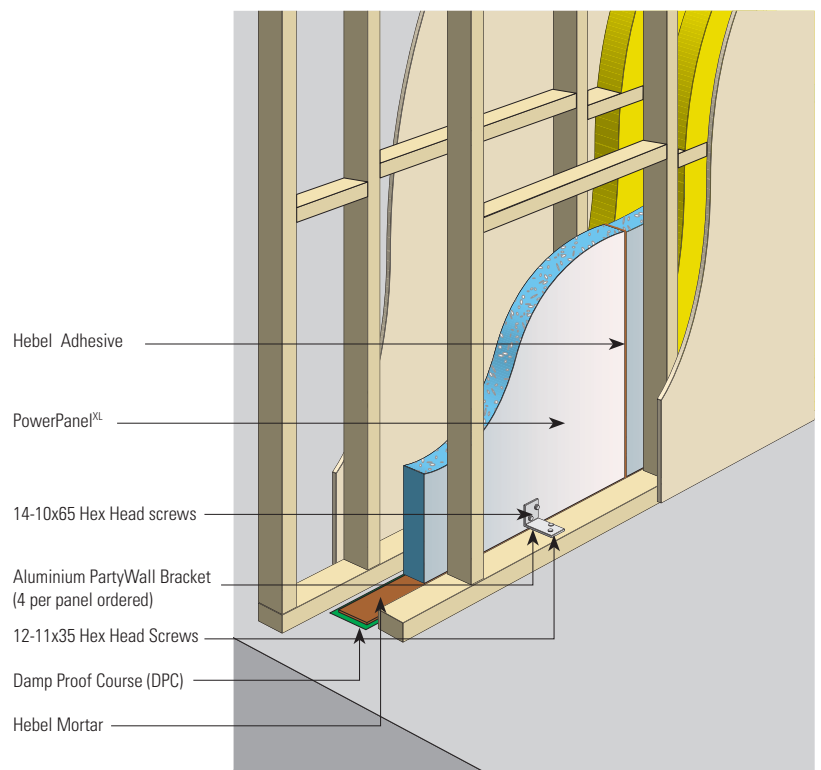

POWERPANEL^{XL}

PRODUCT SIZES

Code	Length	Width	Thick	Description	UoM	Order Unit	Quantity / Unit	Weight / Pallet
PowerPanel - Standard Range 75								
21866	1200	600	75	Powerpanel 1200 x 600 x 75 SQ1M0	m2	Pack	10	390
118891	1800	600	75	Powerpanel 1800 x 600 x 75 SQ1M0	m2	Pack	10	580
PowerPanel^{XL} - Standard Range 75								
118014	2400	600	75	PowerPanel ^{XL} 2400 x 600 x 75 SQ1M0	m2	Pack	10	605
118015	2550	600	75	PowerPanel ^{XL} 2550 x 600 x 75 SQ1M0	m2	Pack	10	643
118016	2700	600	75	PowerPanel ^{XL} 2700 x 600 x 75 SQ1M0	m2	Pack	10	680
118017	2800	600	75	PowerPanel ^{XL} 2800 x 600 x 75 SQ1M0	m2	Pack	10	710
118019	2850	600	75	PowerPanel ^{XL} 2850 x 600 x 75 SQ1M0	m2	Pack	10	718
118020	3000	600	75	PowerPanel ^{XL} 3000 x 600 x 75 SQ1M0	m2	Pack	10	756
126504	3300	600	75	PowerPanel ^{XL} 3300 x 600 x 75 SQ1M0	m2	Pack	10	830
PowerPanel^{XL} - Made to Length in 5mm increments								
MTL 31	2400 to 3300	600	75	Made to Length PowerPanel ^{XL} 1M	m2	Each	10	-

SQ = Square Edge, 1M = Single Mesh, 0 = No Bevel.

Notes:

1. All Made to Length panels are: Made to Confirmed Order Only – Minimum Quants Apply – Lead Times Apply.
2. Weight may vary due to moisture content.

ACCESSORIES

Code	Description	Main Application	UoM	Order Unit	Quantity / Unit
Brackets					
40900	Aluminium Party Wall Bracket	Attach PowerPanel ^{XL} to int. frame	Each	Each	1
21882	Deflection Head 76mm x 50mm x 3m x 0.8mm BMT	Deflection Head for PowerPanel ^{XL}	Each	Each	1
General Purpose Screws					
21900	Screw 14-10 x 65mm Head Head Type 17	Int. fix Aluminium bracket to PowerPanel ^{XL}	Box	Box	500
106882	Screw 12-11 x 35mm Head Head Type 17	Fix TopHat to timber frame	Box	Box	500
21906	Screw 10-16 x 16mm Hex Head Tekes	Fix Aluminum bracket to steel stud frame	Box	Box	1000
44174	Screw 14-10 x 150mm Hex Head Type 17	Fix Aluminum bracket to timber frame	Box	Box	250
Adhesives and Coatings					
21933	Hebel Adhesive	All systems	Bag	20kg Bag	1
21935	Hebel Mortar	All systems	Bag	20kg Bag	1
21949	Hebel Patch	All systems	Bag	10kg Bag	1
25594	Hebel Anti - Corrosion Paint 500ml	Used to coat exposed reo	Each	Each	1
122116	CSR FireSeal - Fire & Acoustic Sealant	All systems	Box	Box	12
Hand Tools					
21901	PowerPanel Lifters 16mm	Handling system for PowerPanel	Pair	Pair	1
119426	Panel Separator Kit	For all systems	Each	Each	1
162645	2 Wheel Panel Mover	Handling system for PowerPanel	Each	Each	1
130324	Installer PowerPanel Trolley	Handling system for PowerPanel	Each	Each	1

PowerPanel⁵⁰



FOR FAST SOLID WALLS WITH
A RENDERED FINISH, 50MM
EXTERNAL WALL SYSTEMS SIMPLE
AND EASY TO INSTALL.

EXTERNAL WALLS

- HOUSES
- LOW RISE MULTI RESIDENTIAL

APPLICATIONS

HOUSES & MULT RESIDENTIAL

External walls



CODEMARK
Australia
CM40233

- Strong, solid external walls, finished with a flexible coating system
- Good thermal performance, helping to keep the house cooler in summer and warmer in winter
- Good acoustic performance – keeping external noises to a minimum
- Fast to construct without compromising on quality – one standard Hebel panel is the equivalent of 75 traditional bricks, which means an average sized house can go up as quickly as 3 days when installed by experienced Hebel installers
- Non-combustible, suitable for build in bushfire zones

POWERPANEL⁵⁰ EXTERNAL WALL SYSTEM

The PowerPanel⁵⁰ system consists of 50mm thick, steel-reinforced AAC panels, vertically secured to the structural frame via horizontal perforated top hat sections. The wall is then rendered with a recommended coating system – providing a faster way of constructing external facades for residential builds.

System Application	Fire	Acoustic	Thermal	Wall thickness
PowerPanel ⁵⁰ 50mm external wall system	90/90/90 mins from panel side only. Suitable for bushfire zones up to BAL (FZ).	R _w = 35dB, R _w +C _{tr} = 31dB for panel ONLY	R-value = 0.313 m ² .K/W for 4% M.C for panel ONLY. The external wall system may achieve R-value up to 3.72 m ² .K/W in wall system (refer to current D&I Guide for details).	139mm to 187mm

Our System Specification Finder helps you find the best system for your next project.

Visit www.hebel.com.au/specification-tool

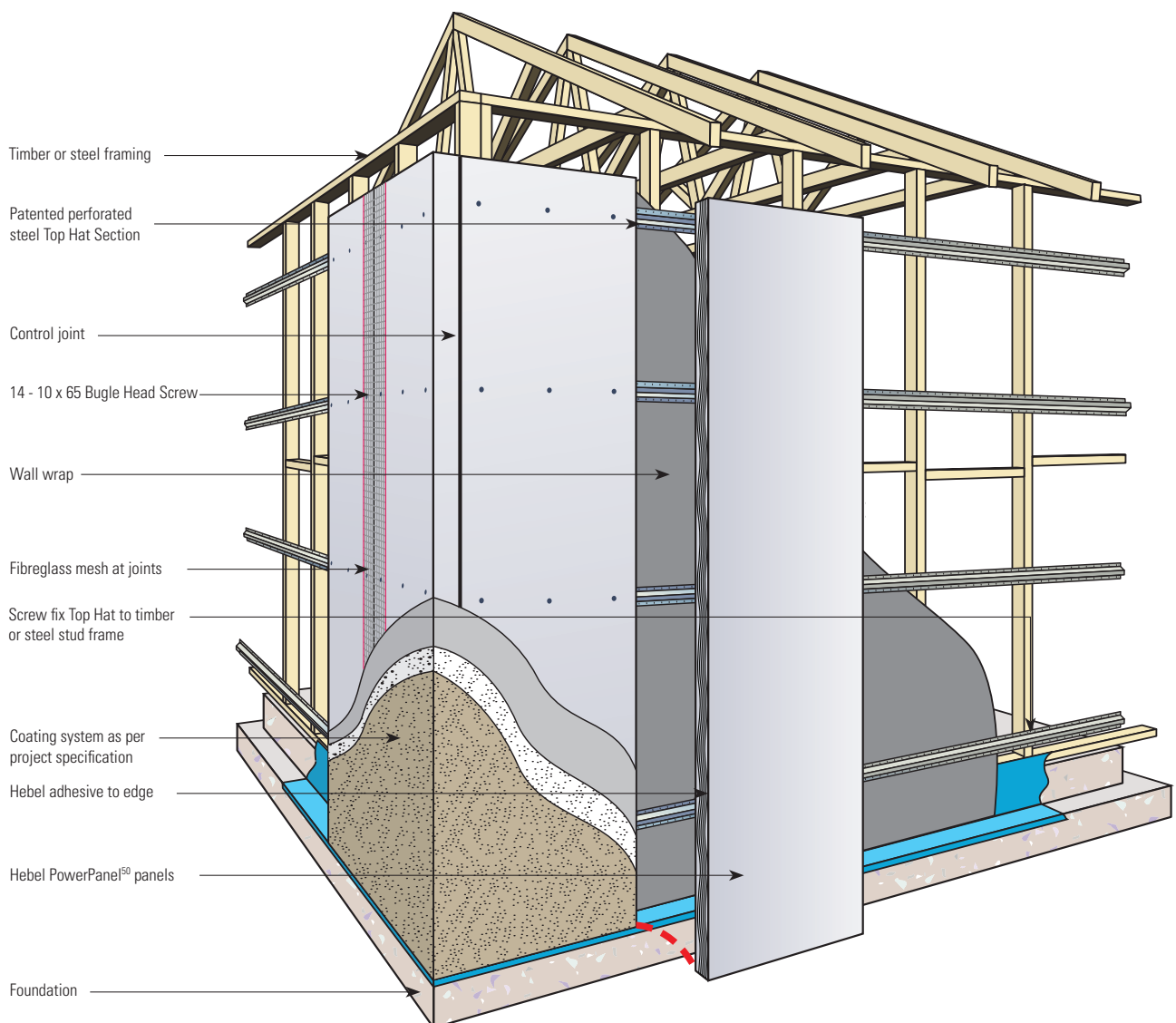

PRODUCT SIZES

Code	Length	Width	Thick	Description	Main Application	UoM	Order Unit	Quantity / Unit	Weight / Pallet
99939	2400	600	50	PowerPanel ⁵⁰ 2400 x 600 x 50 SQ1M0	External Walls	M2	Pack	15	750
133805	2550	600	50	PowerPanel ⁵⁰ 2550 x 600x 50 SQ1M0		M2	Pack	15	820
162758	2700	600	50	PowerPanel ⁵⁰ 2700 x 600 x 50 SQ1M0		M2	Pack	15	870
162756	2850	600	50	PowerPanel ⁵⁰ 2850 x 600 x 50 SQ1M0		M2	Pack	15	915
162760	3000	600	50	PowerPanel ⁵⁰ 3000 x 600 x 50 SQ1M0		M2	Pack	15	960

SQ = Square Edge, 1M = Single Mesh, 0 = No Bevel

ACCESSORIES

Code	Description	Main Application	UoM	Order Unit	Quantity / Unit
21909	Perforated top hat 24mm x 4.8m x 0.42mm BMT	Attaching PowerPanel ⁵⁰ to frame	1	Each	Each
105536	Perforated top hat 35mm x 4.8m x 0.55mm BMT	Attaching PowerPanel ⁵⁰ to frame	1	Each	Each
21906	Screw 10-16 x 16mm Hex Head	Fix top hat to steel stud frame and fix top hat to direct fix clip	Box	Box	1000
21906	Screw 10-16 x 16mm Hex Head	Fix Aluminium bracket to steel stud frame	Box	Box	1000
106882	Screw 12-11 x 35mm Hex Head Type17	Fix top hat to timber frame	Box	Box	500
163902	Screw 14-10 x 65mm Bugle Head Type 17	Int. fix PowerPanel ⁵⁰ to top hat	Box	Box	500
Adhesives and Coatings					
21933	Hebel Adhesive	All systems	Bag	20kg Bag	1
21949	Hebel Patch	All systems	Bag	10kg Bag	1
25594	Hebel Anti-Corrosion Paint 500ml	Used to coat exposed reo	Each	Each	1
111161	Hebel Base Sealer 5L	Waterproofing for residential	Each	Each	1

PowerPanel⁵⁰

PATENTED
POWERPANEL⁵⁰
IN LENGTHS UP TO
3 METRES

REVOLUTIONARY 50MM THICK PANEL IN LENGTHS UP TO 3 METRES – DEVELOPED, TESTED AND CSR WARRANTED FOR LOW RISE MULTI-RESIDENTIAL INTERTENANCY AND DUAL ZERO BOUNDARY WALLS.

INTERTENANCY/PARTYWALLS & DUAL ZERO BOUNDARY WALLS

■ TOWNHOUSES, VILLAS & OTHER LOW RISE MULTI RESIDENTIAL PROJECTS

APPLICATIONS

LOW RISE MULTI RESIDENTIAL USING POWERPANEL⁵⁰ 50MM PANEL THICKNESS

Intertency / Party Walls



- Fast and easy system to install
- Easy to fire-rate with no need for fire-rated plasterboard between floor levels at joists and in roof space
- Narrow system wall width - starting at 230mm – with 70mm separation between stud frames across all systems
- Simple system componentry maximises construction efficiency
- Panels up to 3 metres in height installed vertically
- Easy to cut PowerPanel⁵⁰ panels onsite
- PowerPanel⁵⁰ wall construction not affected by wet or damp conditions
- Minimal onsite waste
- Environmentally responsible building material

Dual Zero Boundary Walls



- Fast and easy system to install with Hebel Hoist
- Perfect solution for separate title construction
- Narrow wall widths
- Hoist system enables all frames to be constructed first
- Simple, proven system

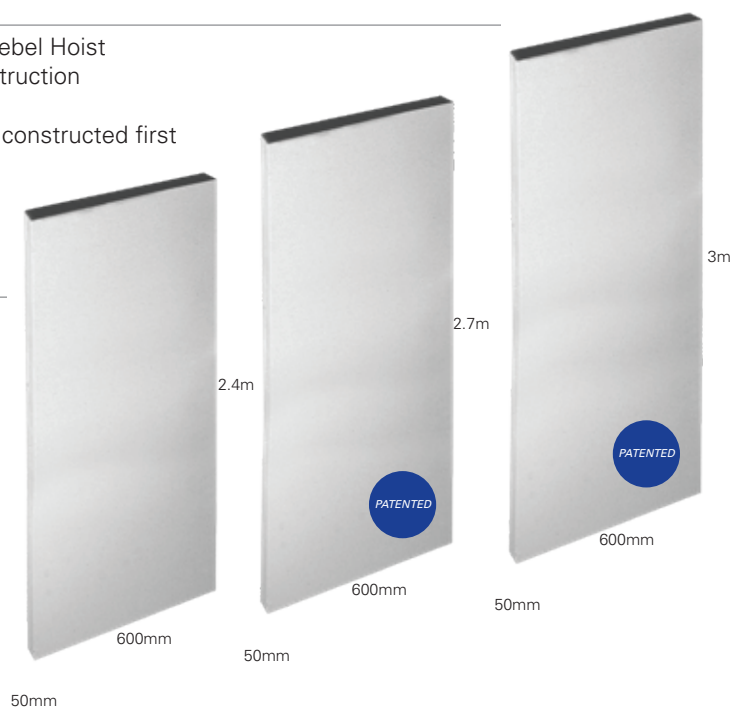

POWERPANEL⁵⁰

POWERPANEL⁵⁰ INTERTENANCY / PARTY WALL

The PowerPanel⁵⁰ Intertency Wall System consists of 50mm thick steel reinforced AAC panels installed vertically to timber or steel frame. Uses aluminium wall brackets for discontinuous construction and Hebel deflection head track for base connection.

Our System Specification Finder helps you find the best system for your next project.

Visit www.hebel.com.au/specification-tool

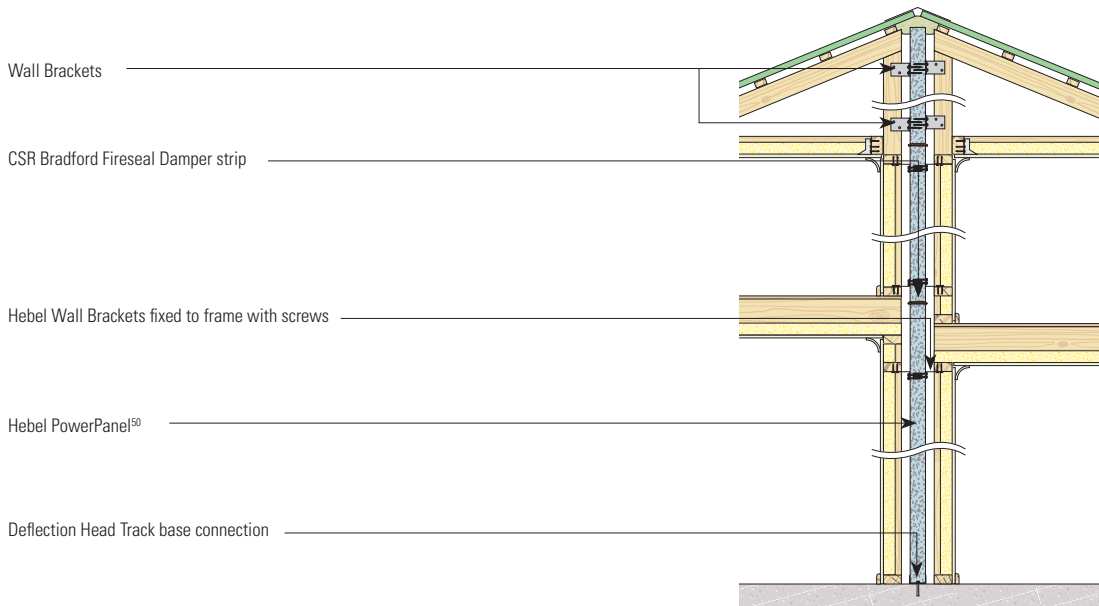

POWERPANEL⁵⁰ DUAL ZERO BOUNDARY WALLS

Construction of the non-loadbearing Powerpanel⁵⁰ Dual Zero Boundary wall is achieved by installing 50mm thick Hebel panels vertically - using Hebel Top Hats and Direct Fix Clips to fix panels to the structural timber or steel frame. When using the Hebel Hoist system all frames can be installed first.

Our System Specification Finder helps you find the best system for your next project.

Visit www.hebel.com.au/specification-tool

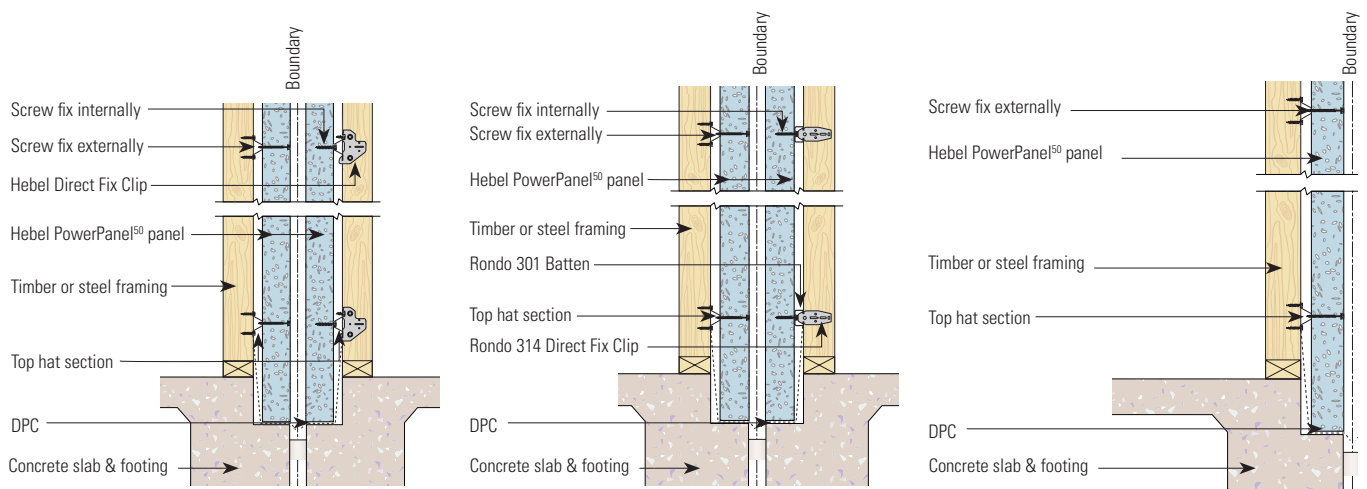

PRODUCT SIZES

Code	Length	Width	Thick	Description	Main Application	UoM	Order Unit	Quantity / Unit	Weight / Pallet
99939	2400	600	50	PowerPanel ⁵⁰ 2400 x 600 x 50 SQ1M0	Residential Intertency / Party & Dual Zero Boundary Walls	M2	Pack	15	750
162758	2700	600	50	PowerPanel ⁵⁰ 2700 x 600 x 50 SQ1M0		M2	Pack	15	870
162760	3000	600	50	PowerPanel ⁵⁰ 3000 x 600 x 50 SQ1M0		M2	Pack	15	960

SQ = Square Edge, 1M = Single Mesh, 0 = No Bevel

ACCESSORIES

Code	Description	Main Application	UoM	Order Unit	Quantity / Unit
Intertency/Party Walls Accessories					
176867	Deflection Head 51mm x 3m x 0.7mm BMT	50mm Party Wall Base - Residential Connection	Each	Each	Pack
40900	Aluminium Party Wall Bracket	Attach PowerPanel ⁵⁰ to int. frame	Each	Each	1
182233	Fireseal Damper Strip 15/Pack 750mm long x 225mm wide x 13mm thick	Horizontal Control Joint	Each	Each	Each
193379	Fireseal Partywall Sealer 2/Pack 4000mm long x 300mm wide x 50mm thick	Used as sealer between panel and roof / wall cavities	Pack	Pack of 2	Pack
21906	Screw 10-16 x 16mm Hex Head	Fix Aluminium bracket to steel stud frame	Box	Box	1000
106882	Screw 12-11 x 35mm Hex Head Type17	Int. fix Aluminium bracket to timber frame Int. fix Aluminium bracket to PowerPanel ⁵⁰	Box	Box	500
Dual Zero Boundary Walls Accessories					
21909	Perforated top hat 24mm x 4.8m x 0.42mm BMT	Attaching PowerPanel ⁵⁰ to frame	1	Each	Each
105536	Perforated top hat 35mm x 4.8m x 0.55mm BMT	Attaching PowerPanel ⁵⁰ to frame	1	Each	Each
192101	RONDO 301 Batten 16mm x 4.8m x 0.42 BMT	Fixing PowerPanel ⁵⁰ to the structural support framing using the RONDO 314 Direct Fix Clip	Each	Each	Each
168120	Hebel Direct Fixing Clip (Exclusive to Hebel Dual Zero Boundary Wall clips) - 200 / box	Attaching 24mm or 35mm top hats to stud frame	1	Box	200
193703	Rondo Clip 314	For attaching RONDO 301 16mm batten to structural stud frame - Dual Zero Boundary Wall	1	Box	100
21906	Screw 10-16 x 16mm Hex Head	Fix top hat to steel stud frame and fix top hat to direct fix clip	Box	Box	1000
106882	Screw 12-11 x 35mm Hex Head Type17	Fix top hat to timber frame and fix top hat to direct fix clip Int. fix PowerPanel ⁵⁰ to top hat	Box	Box	500
21900	Screw 14-10 x 65mm Hex Head	Int. fix PowerPanel ⁵⁰ to top hat	Box	Box	500
Adhesives and Coatings					
21933	Hebel Adhesive	All systems	Bag	20kg Bag	1
21935	Hebel Mortar	All systems	Bag	20kg Bag	1
21949	Hebel Patch	All systems	Bag	10kg Bag	1
25594	Hebel Anti-Corrosion Paint 500ml	Used to coat exposed reo	Each	Each	1
111161	Hebel Base Sealer 5L	Waterproofing for residential	Each	Each	1
122116	CSR FireSeal - Fire & Acoustic Sealant	All systems	Box	Box	12

PowerFloor



PROVIDES AN EXCELLENT FLOORING SOLUTION WITH THE FEEL OF A SOLID CONCRETE FLOOR WITHOUT THE COST.

FLOORS

- HOUSES
- MULTI-RESIDENTIAL

APPLICATIONS

FLOORS

- offers excellent acoustic performance, minimising noise transference between floors
- easily installed by onsite tradesman such as carpenters
- not affected by weather during installation
- once finished, the Hebel PowerFloor system provides a solid base for just about any floor covering.

POWERFLOOR FLOORING SYSTEM

The strong and solid flooring system consists of PowerFloor 75mm steel-reinforced tongue and groove panels. These panels are installed over steel or timber joists to provide an outstanding flooring solution for suspended ground floors or mid-floors.

FRL	Acoustic	Thermal	PowerFloor thickness
Up to 90 minutes from above, up to 90 minutes from below (with approved CSR Gyprock ceiling) Acoustic	Without ceiling system Rw + Ctr 33 to 39dB, Lnw + C1 45 to 82dB With ceiling system Rw + Ctr 48 to 54dB, Lnw + C1 30 to 74dB	R0.59 to R3.49*	75mm

Our System Specification Finder helps you find the best system for your next project.

Visit www.hebel.com.au/specification-tool

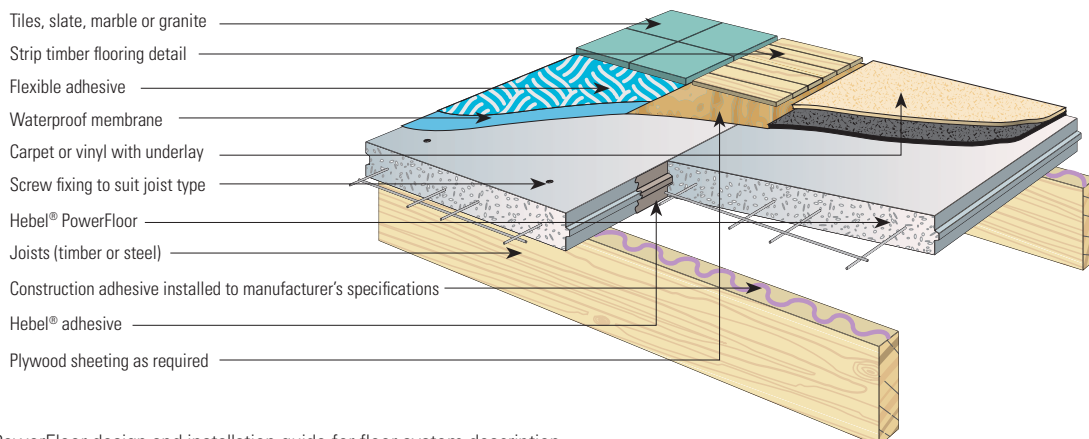

*Refer to Hebel PowerFloor design and installation guide for floor system description.

PRODUCT SIZES

Code	Length	Width	Thick	Description	UoM	Order Unit	Quantity / Unit	Weight / Pallet
PowerFloor 75								
21987	1800	600	75	PowerFloor 1800 x 600 x 75 T&G1M0	m2	Pack	10	596

T&G = Tongue & Groove; 1M = Single Mesh, 0 = No Bevel.
 Note: Weight may vary due to moisture content.

ACCESSORIES

Code	Description	Main Application	UoM	Order Unit	Quantity / Unit
PowerFloor Screws					
41235	Screw 14-10 x 100mm Bugle Head	Fix PowerFloor to timber joists	Box	Box	250
29041	Screw 14-10 x 95mm Hex Head	Fix PowerFloor to steel joist	Box	Box	500
Adhesives and Coatings					
21933	Hebel Adhesive	All systems	Bag	20kg Bag	1
21949	Hebel Patch	All systems	Bag	10kg Bag	1
25594	Hebel Anti - Corrosion Paint 500ml	Used to coat exposed reo	Each	Each	1

PowerFence



PROVIDES AN INNOVATIVE MODULAR, SOLID FENCING SYSTEM THAT'S ATTRACTIVE, VERSATILE AND EASY TO INSTALL.

FENCING

- HOUSES
- MULTI-RESIDENTIAL

APPLICATIONS

HOUSES & MULTI-RESIDENTIAL

Fencing

- easy to build, cost effective and attractive
- creates privacy and acts as a reflective noise barrier
- perfect for boundary fencing or as an alternative to standard masonry front fences
- can change the wall profiles (monolithic or expressed) and create a range of looks with caps, finishes and routing patterns

POWERFENCE FENCING SYSTEM

Ideal for renovators, because of the lightweight panels and simple construction method, PowerFence uses standard 1800 x 600 x 75mm PowerPanels, steel brackets and steel posts which can be easily and quickly erected without the need for excavation or strip footing. Ideal for houses, multi-residential projects, low-rise apartments and DIY projects.

Our System Specification Finder helps you find the best system for your next project.

Visit www.hebel.com.au/specification-tool

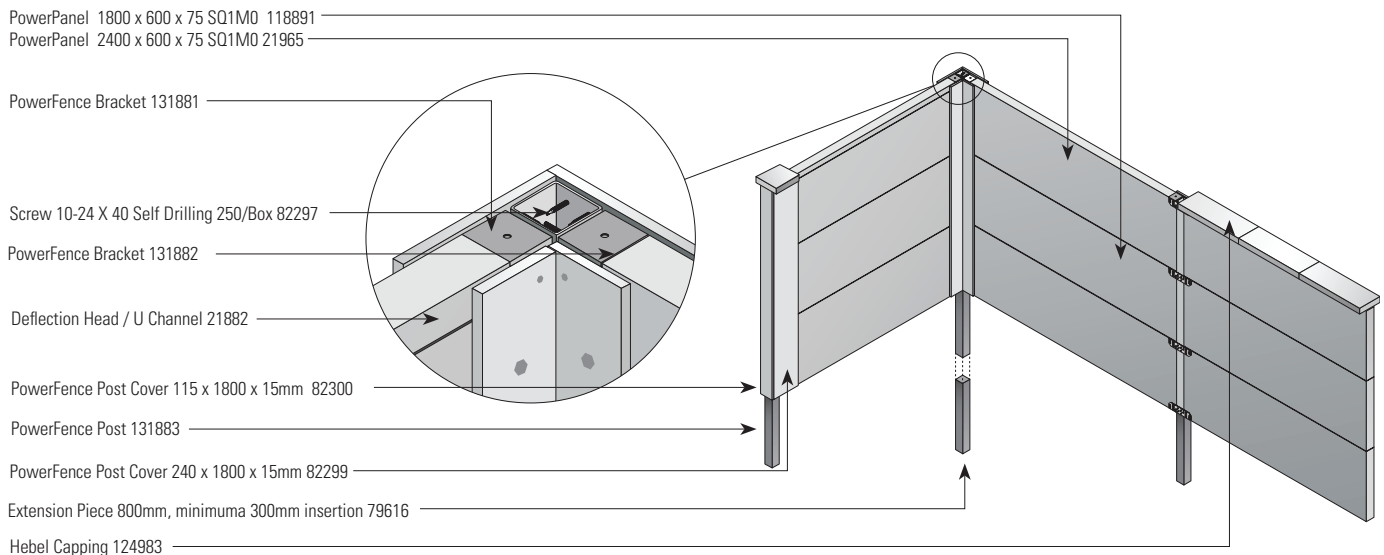

POWERFENCE

THE HEBEL POWERFENCE BRACKET

Multi-purpose and adjustable for all-round easier and safer construction. Move it up or down while constructing. Rotate it to make a corner. Turn it upside down for a starting cleat. Use it as a lateral support for all the panels. Separate its two integrated sections for stepped or terraced fencing. Easy to position and refix as you go.

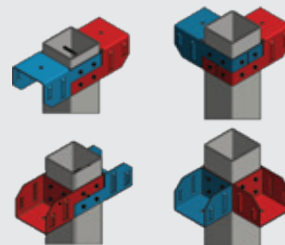

PRODUCT SIZES

Code	Length	Width	Thick	Description	UoM	Order Unit	Quantity / Unit	Weight / Pallet
PowerFence - Standard Range 75								
118891	1800	600	75	Powerpanel 1800 x 600 x 75 SQ1M0	m2	Pack	10	580
21965	2400	600	75	PowerPanel 2400 x 600 x 75 SQ1M0	m2	Pack	10	770

SQ = Square Edge, 1M = Single Mesh, 0 = No Bevel.

Note: Weight may vary due to moisture content.

ACCESSORIES

Code	Description	Main Application	UoM	Order Unit	Quantity / Unit
PowerFence Accessories					
82297	Screw 10-24 x 40mm Self Drilling	PowerFence	Box	Box	250
133341	PowerFence Bracket Set	PowerFence	Each	Each	1
131883	PowerFence Post	PowerFence	Each	Each	1
79616	PowerFence Post Extension Piece 800mm	PowerFence	Each	Each	1
82300	PowerFence Post Cover 115 x 1800 x 15mm	Vertical express FC post cover	Each	Each	1
82299	PowerFence Post Cover 240 x 1800 x 15mm	Vertical express FC post cover	Each	Each	1
124983	Hebel Capping Pack	Hebel capping block 600 x 200 x 50	Each	Pack	6
21882	Deflection Head 76mm x 50mm x 3m x 0.8mm BMT	Deflection head for PowerPanel	Each	Each	1
Adhesives and Coatings					
21933	Hebel Adhesive	All systems	Bag	20kg Bag	1
21949	Hebel Patch	All systems	Bag	10kg Bag	1
25594	Hebel Anti - Corrosion Paint 500ml	Used to coat exposed reo	Each	Each	1

PowerPanel

Tongue & Groove



Single mesh & caged T&G

FOR SOLID, SECURE WALLS THAT ARE FAST TO CONSTRUCT AND EASY TO ACHIEVE NCC FIRE AND ACOUSTIC RATING COMPLIANCE.

INTERTENANCY, CORRIDOR, SHAFT & SERVICES WALL SYSTEMS

- APARTMENTS
- HOTELS
- STUDENT ACCOMMODATION
- COMMERCIAL & INDUSTRIAL

APPLICATIONS

HIGH RISE APARTMENTS, HOTELS, STUDENT ACCOMMODATION AND COMMERCIAL & INDUSTRIAL

Intertenancy walls

- 5 wall system types including 3 for bathroom pods
- System for *concealed water services one side* 185mm thick - one of narrowest in market enabling maximised use of floor space and greater design flexibility
- Fire rating level (FRL) -/90/90 for wall heights up to 3.3 metres with PowerPanel T&G
- FRL -/120/120 for walls up to 4.65m when using PowerPanel caged T&G installed vertically

Corridor walls

- 3 wall system types including one for bathroom pods
- System for *concealed water services one side* 180mm thick - one of narrowest in market, enabling maximised use of floor space and greater design flexibility
- Fire rating level (FRL) -/90/90 for wall heights up to 3.3 metres with PowerPanel T&G
- FRL -/120/120 for walls up to 4.65m when using PowerPanel caged T&G installed vertically

Shaft walls

- 3 wall system types including one for bathroom pods
- Dry area system provides solid, secure wall with a narrow width around service shaft and between scissor stairs
- Wet area system for general partitions between service shaft and wet areas or adjacent to common areas
- For wall heights up to 3.3m, FRL -/90/90 and FRL -120/120 depending on system
- For wall heights higher than 3.3m and up to 4.65m (vertical), caged T&G PowerPanel can be used which will achieve a FRL of -/120/120.
- Can be installed horizontally to maximum panel length of 4800mm and to an unlimited height without need for thin bed adhesive at panel joints.

Services walls

- isolates and secures plant rooms from other areas of building
- FRL -/90/90 for wall heights up to 3.3m with PowerPanel T&G
- For tall shaft risers with fire ratings up to 2 hours, PowerPanel can be installed horizontally to unlimited height without need for thin bed adhesive at panel joints.

HEBEL INTERTENANCY WALL SYSTEM FOR CONCEALED WATER SERVICES ONE SIDE

The Hebel PowerPanel wall leaf construction reaches from the slab to the soffit and is the fire-rated element. Panels can be ordered to length for easy installation and minimal waste. Plasterboard linings aren't required to go past the ceiling for NCC fire-rating compliance. Only two types of plasterboard lining need to be considered for most system types – standard or moisture resistant. Ceiling frames can be installed either before or after linings.

Our System Specification Finder helps you find the best system for your next project.

Visit www.hebel.com.au/specification-tool

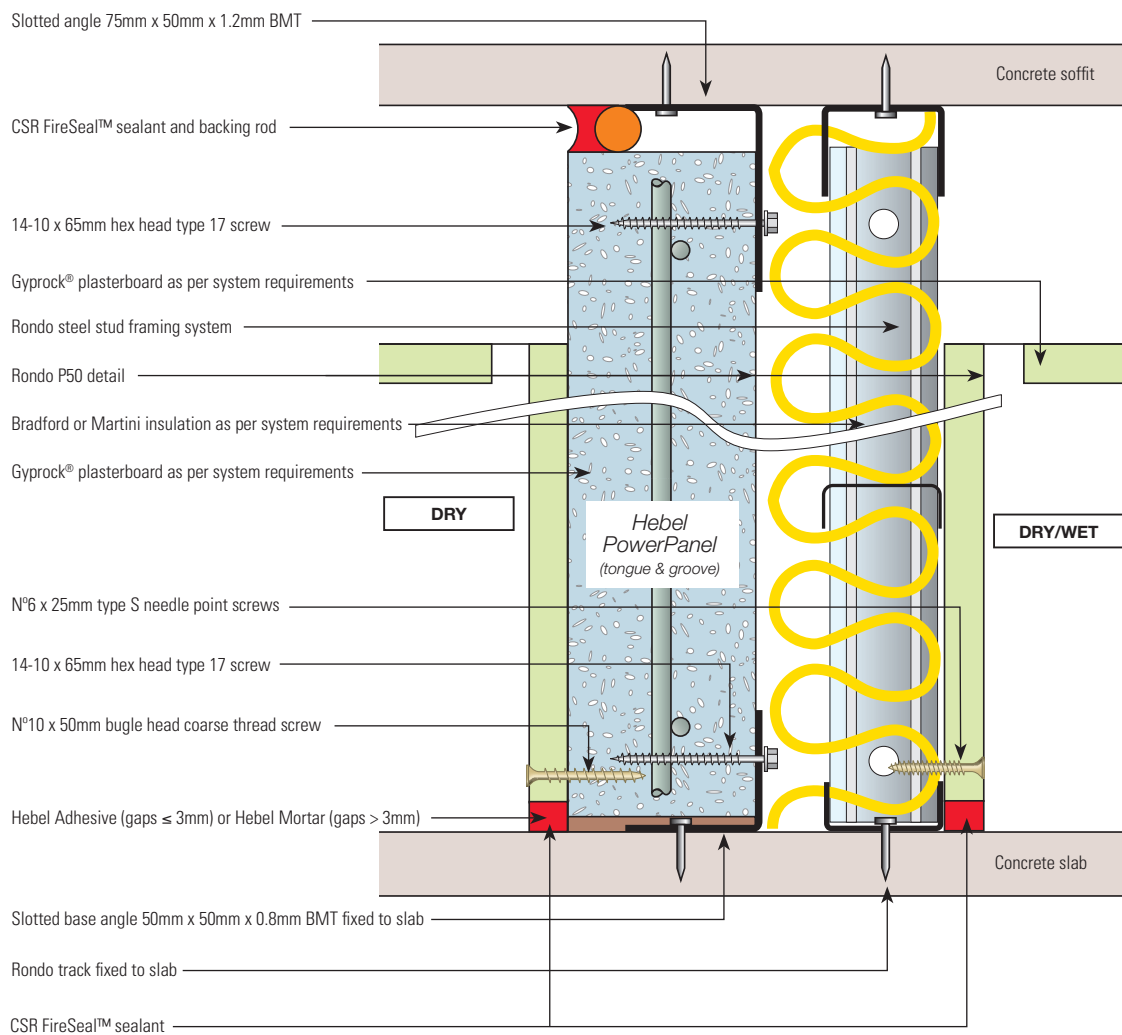

PRODUCT SIZES

Code	Length	Width	Thick	Description	Main Application	UoM	Order Unit	Quantity / Unit	Weight / Pallet
PowerPanel - Tongue and Groove 75									
118260	2700	600	75	PowerPanel 2700 x 600 x 75 T&G1M0	Internal walls	m2	Pack	10	861
118281	2800	600	75	PowerPanel 2800 x 600 x 75 T&G1M0	Internal walls	m2	Pack	10	900
118282	2850	600	75	PowerPanel 2850 x 600 x 75 T&G1M0	Internal walls	m2	Pack	10	920
123546	2900	600	75	PowerPanel 2900 x 600 x 75 T&G1M0	Internal walls	m2	Pack	10	930
118283	3000	600	75	PowerPanel 3000 x 600 x 75 T&G1M0	Internal walls	m2	Pack	10	960
118284	3300	600	75	PowerPanel 3300 x 600 x 75 T&G1M0	Internal walls	m2	Pack	10	1060
PowerPanel 75 - Made to Length in 5mm increments									
MTL 24	1800 to 3300	600	75	Made to Length PowerPanel 1M	Internal walls	m2	Each	10	-
PowerPanel 75 - Standard Range - Caged 75mm									
152225	3600	600	75	PowerPanel 3600 x 600 x 75 T&G2M0	Internal walls	m2	Pack	10	1190
152227	4200	600	75	PowerPanel 4200 x 600 x 75 T&G2M0	Internal walls	m2	Pack	10	1385
PowerPanel 75 - Made to Order in 5mm increments - Caged 75mm									
MTO 02	Up to 4800	300-600	75	Made to Order PowerPanel 2M	Internal & external walls	m2	Each	10	-

T&G = Tongue & Groove; 1M = Single Mesh; 2M = Caged; 0 = No Bevel.

All Made to Length and Made to Order products are: Made to Confirmed Order Only – Minimum Quants Apply – Lead Times Apply – Engineering Checks Apply to MTO orders.

- Notes:
1. Panels are cuttable in length - max 150mm each end.
 2. Weight may vary due to moisture content.

ACCESSORIES

Code	Description	Main Application	UoM	Order Unit	Quantity / Unit
Metal Angles					
21938	Slotted Base Angle 50mm x 50mm x 2.4m x 0.8mm BMT	Base support for int. h/rise walls	Each	Each	1
21957	Slotted Angle 75mm x 50mm x 2.7m x 1.2mm BMT	Head support angle	Each	Each	1
General Purpose Screws					
21900	Screw 14-10 x 65mm Hex Head Type 17	Int. fix PowerPanel to TopHat	Box	Box	500
44174	Screw 14-10 x 150mm Hex Head Type 17	Screw panels together at corners	Box	Box	250
Adhesives and Coatings					
21933	Hebel Adhesive	All systems	Bag	20kg Bag	1
21935	Hebel Mortar	All systems	Bag	20kg Bag	1
21949	Hebel Patch	All systems	Bag	10kg Bag	1
25594	Hebel Anti - Corrosion Paint 500ml	Used to coat exposed reo	Each	Each	1
122116	CSR FireSeal - Fire & Acoustic Sealant	All systems	Box	Box	12
Hand Tools					
21901	PowerPanel Lifters 16mm	Handling system for PowerPanel	Pair	Pair	1
21903	PowerPanel Trolley 2.4-2.7 panels	Handling system for PowerPanel	Each	Each	1
21904	PowerPanel Trolley 2.9-3.35 panels	Handling system for PowerPanel	Each	Each	1
119426	Panel Separator Kit	For all systems	Each	Each	1

PowerPanel

Square Edge



Square edge / Nil profile

DELIVERS A STRONG, SOLID AND HIGHLY FIRE RESISTANT WALL SOLUTION THAT'S COST-EFFECTIVE AND EASY TO INSTALL. FINISHED WITH A QUALITY COATING SYSTEM.

**HIGH RISE FACADES
& BALCONY BLADES**
■ APARTMENTS
■ COMMERCIAL & INDUSTRIAL

APPLICATIONS

APARTMENTS AND COMMERCIAL & INDUSTRIAL

Facades

- non-combustible
- lightweight compared with pre-fabricated concrete and traditional masonry bricks with substantial comparative cost savings
- fast construction timetables (with less reliance on bricklaying trades) and less scaffolding costs
- systemised building components make construction faster and easier than brick
- versatility of design with a pressure equalised system
- solid and secure with high fire rating levels
- good acoustic values dampen exterior noise
- wet weather tolerant (no mould) for storage and building process
- superior coating systems without leaching through the acrylic system

Balcony blades

- non-combustible
- lightweight compared with pre-fabricated concrete and traditional masonry bricks with substantial comparative cost savings
- for narrowest wall width to maximise floor space and keep similar wall width to internal party wall achieving good aesthetic result
- strong acoustic values for added privacy and sound insulation
- enables simple service installation with design integration of adjoining walls
- wet weather tolerant (no mould) for storage and building process

HEBEL HIDDEN SLAB EDGE AND VISIBLE SLAB EDGE FACADE SYSTEMS

These Hebel façade systems are non-loadbearing external wall solutions for high rise apartments and commercial and industrial applications. Hebel Top Hats are used to fix the Hebel PowerPanel to the structural steel stud framing.

The visible slab edge system provides a conventional system to edge beam detailing, with the PowerPanels positioned on the slab edge.

In the hidden slab edge system, the panels are positioned in front of the slab edge. Locating the panels proud of the slab edge produces a single rebated external line at slab level and a more flexible slab edge tolerance.

Our System Specification Finder helps you find the best system for your next project.

Visit www.hebel.com.au/specification-tool

HIDDEN SLAB EDGE

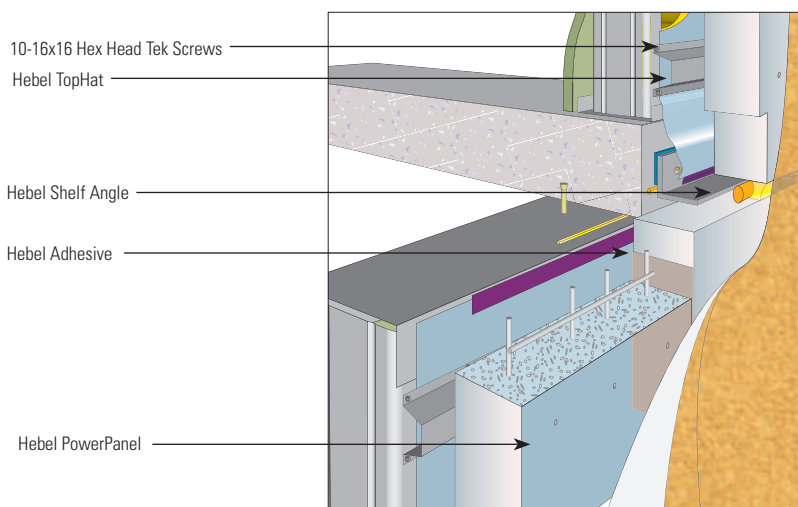

VISIBLE SLAB EDGE

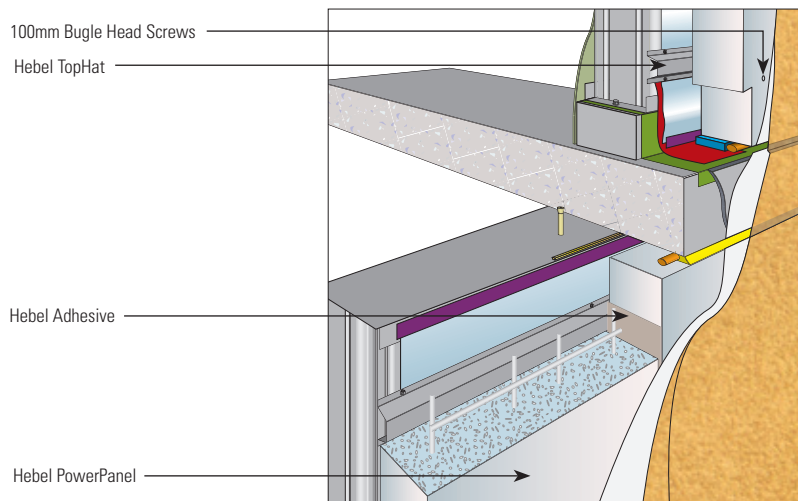

BALCONY BLADES SYSTEM

CSR Hebel has developed a fully engineered slim line balcony blade system for use in high rise residential developments. The blade design has been refined to an overall wall thickness of 200mm. This assists in maximising the usable balcony space, as well as aligning the width with internal walls – an important design aspect.

Our System Specification Finder helps you find the best system for your next project.

Visit www.hebel.com.au/specification-tool

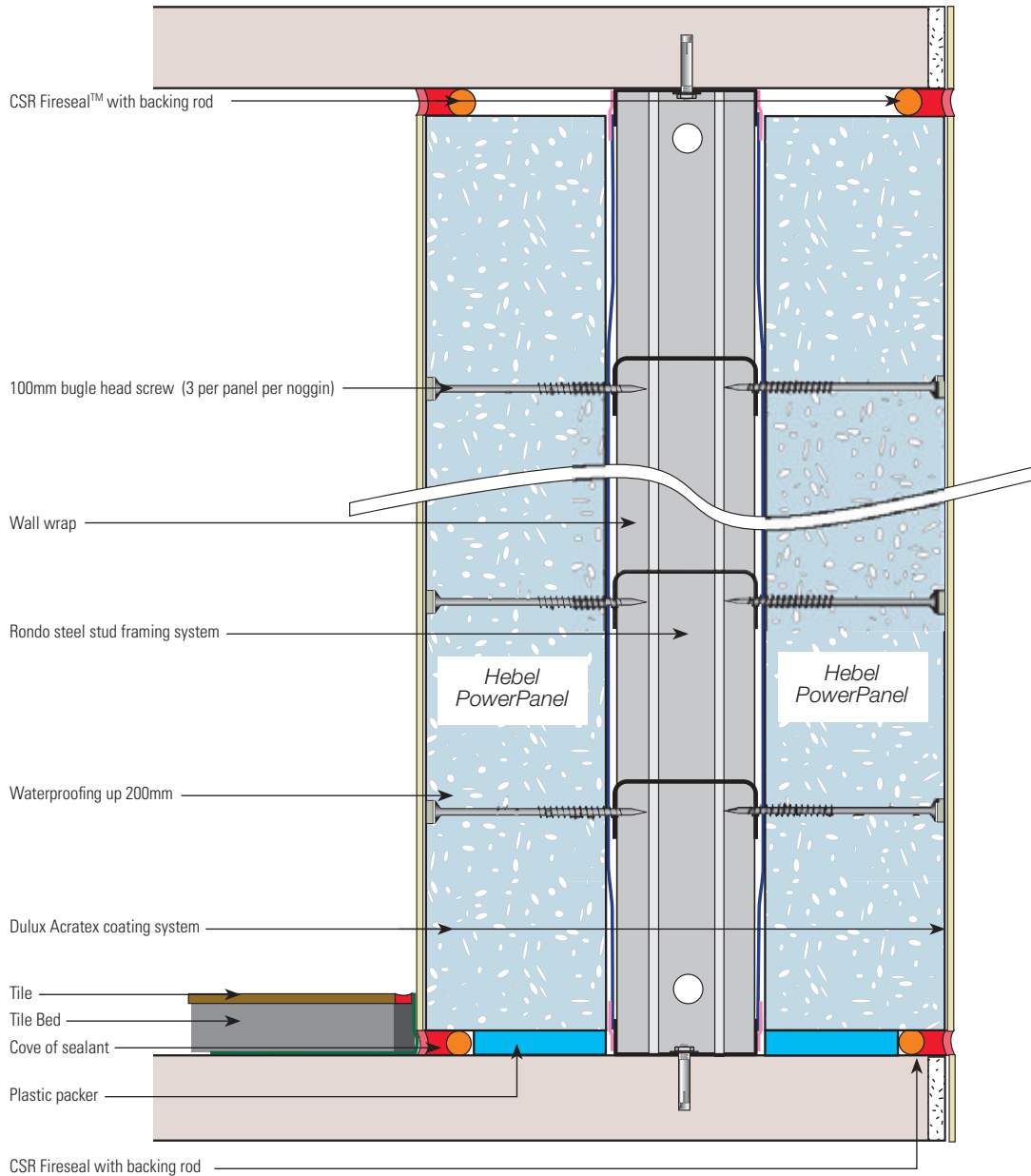

PRODUCT SIZES

Code	Length	Width	Thick	Description	Main Application	UoM	Order Unit	Quantity / Unit	Weight / Pallet
PowerPanel - Standard Range 75									
22077	2800	600	75	PowerPanel 2800 x 600 x 75 SQ1M0	External walls	m2	Pack	10	900
26048	2850	600	75	PowerPanel 2850 x 600 x 75 SQ1M0	External walls	m2	Pack	10	920
21969	3000	600	75	PowerPanel 3000 x 600 x 75 SQ1M0	External walls	m2	Pack	10	957
81462	3300	600	75	PowerPanel 3300 x 600 x 75 SQ1M0	External walls	m2	Pack	10	1100
PowerPanel 75 - Made to Length 5mm increments									
MTL 24	1800 to 3300	600	75	Made to Length PowerPanel 1M	External walls	m2	Each	10	-
PowerPanel 75 - Made to Order in 5mm increments - Caged 75mm									
81463	3600	600	75	PowerPanel 3600 x 600 x 75 SQ2M0	External walls	m2	Pack	10	1190
82055	4200	600	75	PowerPanel 4200 x 600 x 75 SQ2M0	External walls	m2	Pack	10	1385
PowerPanel 75 - Made to Order in 5mm increments - Caged 75mm									
MTO 02	Up to 4800	300-600	75	Made to Order PowerPanel 2M	External walls	m2	Each	10	-

SQ = Square Edge 1M = Single Mesh; 2M = Caged; 0 = No Bevel.

All Made to Length and Made to Order products are: Made to Confirmed Order Only – Minimum Quants Apply – Lead Times Apply – Engineering Checks Apply to MTO orders.
Note: Panels are cuttable in length - max 150mm each end.

ACCESSORIES

Code	Description	Main Application	UoM	Order Unit	Quantity / Unit
TopHats & Angle					
141233	TopHat 50mm x 4.8m x 0.75mm BMT	Attaching PowerPanel to frame	Each	Each	1
126323	Shelf Angle 150mm x 100mm x 3m x 6mm BMT	Base support for PowerPanel	Each	Each	1
178847	Corner Shelf Angel Bracket	Base support for PowerPanel at external corners - facades	Each	Each	1
General Purpose Screws					
41235	Screw 14-10 x 100mm Bugle Head	Ext. fix PowerPanel to TopHat	Box	Box	250
21900	Screw 14-10 x 65mm Hex Head Type 17	Int. fix PowerPanel to TopHat	Box	Box	500
21906	Screw 10-16 x 16mm Hex Head Teks	Fix TopHat to steel stud frame	Box	Box	1000
44174	Screw 14-10 x 150mm Hex Head Type 17	Screw panels together at corners	Box	Box	250
Adhesives and Coatings					
21933	Hebel Adhesive	All systems	Bag	20kg Bag	1
21949	Hebel Patch	All systems	Bag	10kg Bag	1
25594	Hebel Anti - Corrosion Paint 500ml	Used to coat exposed reo	Each	Each	1
122116	CSR FireSeal - Fire & Acoustic Sealant	All systems	Box	Box	12
Hand Tools					
21901	PowerPanel Lifters 16mm	Handling system for PowerPanel	Pair	Pair	1
21903	PowerPanel Trolley 2.4-2.7 panels	Handling system for PowerPanel	Each	Each	1
21904	PowerPanel Trolley 2.9-3.35 panels	Handling system for PowerPanel	Each	Each	1
119426	Panel Separator Kit	For all systems	Each	Each	1

PowerPanel+

Caged Tongue & Groove

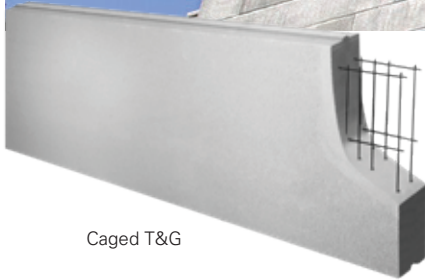

Caged T&G

A HIGH PERFORMING PRODUCT FOR EXTERNAL, INTERNAL AND FIRE TUNNEL WALLS IN COMMERCIAL AND INDUSTRIAL CONSTRUCTION.

EXTERNAL & INTERNAL WALLS & FIRE TUNNELS
 ■ COMMERCIAL
 ■ INDUSTRIAL

APPLICATIONS

COMMERCIAL & INDUSTRIAL

External walls	<ul style="list-style-type: none"> ■ high strength, security and durability ■ lightweight nature of panels compared with concrete reduces loads on structure and size of structural components ■ minimised crane movements and small construction crew requirements ■ high fire rating performance ■ excellent thermal resistance properties ■ effective sound transmission barrier between external and internal environments ■ easy to cut panels, cost-effective Hebel routing to design requirements, panels lengths up to 6 metres
Internal walls	<ul style="list-style-type: none"> ■ lightweight nature of panels compared with concrete reduces loads on structure and size of structural components ■ minimised crane movements and small construction crew requirements ■ high fire rating performance ■ high strength, security and durability ■ suitable for food areas in retail areas and hospitals - solid masonry system deters vermin ■ excellent thermal resistance performance ■ effective sound transmission barrier
Fire tunnels	<ul style="list-style-type: none"> ■ ideal for Hebel ceiling and wall leaf construction ■ cost efficiencies through speed of installation and minimised structural sizes ■ high strength, security and durability ■ slender walls - wall thickness can be reduced by up to 40mm compared to other wall systems providing more lettable area ■ excellent fire protection properties ■ less waste - minimal onsite cutting as panels can be made to required length ■ minimised crane movements ■ small construction crew requirements ■ no wet trades - less mess and a cleaner, safer work area.

POWERPANEL+ EXTERNAL AND INTERNAL WALL SYSTEMS

PowerPanel+ installed vertically or horizontally to concrete structure or steel stud framing as a non-loadbearing external or internal wall system.

Our System Specification Finder helps you find the best system for your next project.

Visit www.hebel.com.au/specification-tool

VERTICAL PANEL CONNECTIONS

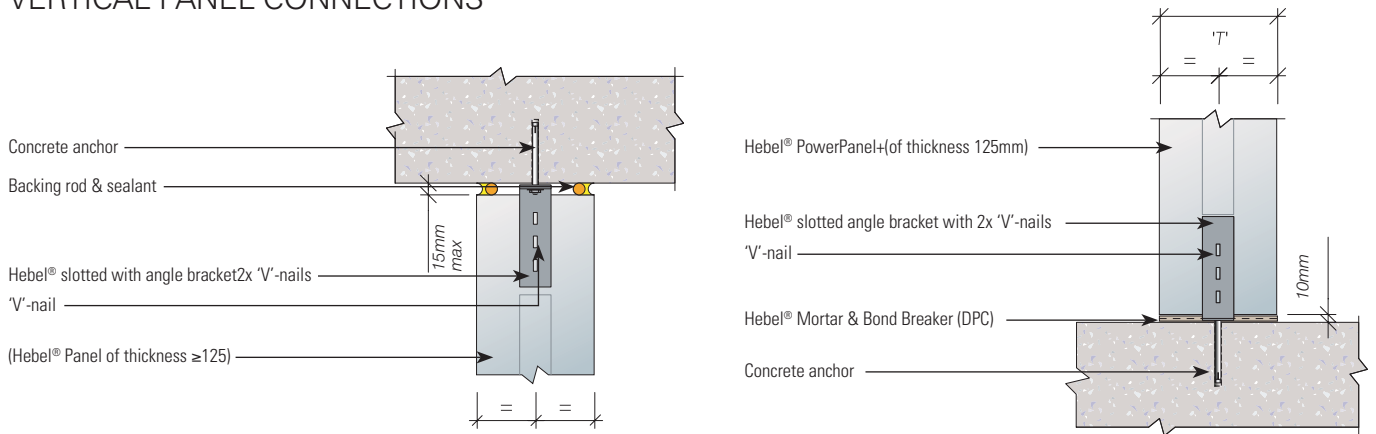

HORIZONTAL PANEL CONNECTION

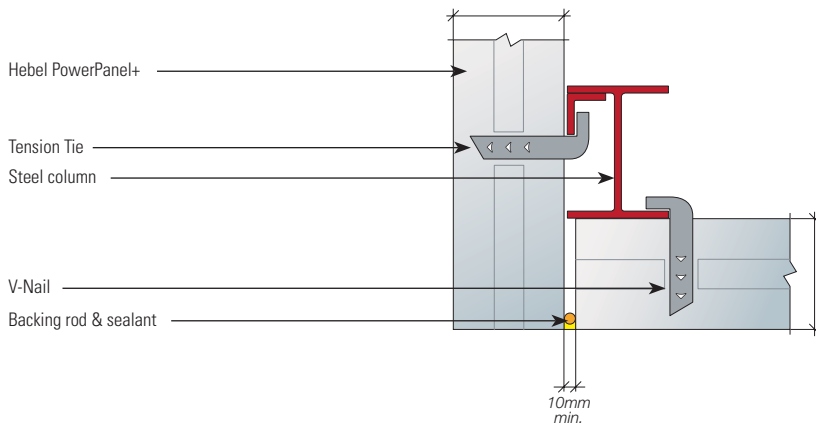

PRODUCT SIZES

Code	Length	Width	Thick	Description	Main Application	UoM	Order Unit	Quantity / Unit	Weight / Pallet
PowerPanel+ 100 - Commercial Wall Panels - Non Cuttable - (100mm Panel is offset T&G only)									
21994	2700	450	100	PowerPanel+ 2700 x 450 x 100 T&G2M5	1.0kPa Serv load	m2	Each	8	816
26481	3000	450	100	PowerPanel+ 3000 x 450 x 100 T&G2M5	1.0kPa Serv load	m2	Each	8	904
81464	4500	600	100	PowerPanel+ 4500 x 600 x 100 T&G2M5-C	1.50kPa Ult load - 0.60kPa Serv load	m2	Each	8	1816
PowerPanel+ 125 - Commercial Wall Panels - Non Cuttable									
81465	4500	600	125	PowerPanel+ 4500 x 600 x 125 T&G2M10-C	2.20kPa Ult load - 1.10kPa Serv load	m2	Each	6	1560
60287	5990	600	125	PowerPanel+ 5990 x 600 x 125 T&G2M10-C	1.20kPa Ult load - 0.50kPa Serv load	m2	Each	6	2262
PowerPanel+ 150 - Commercial Wall Panels - Non Cuttable									
81466	4500	600	150	PowerPanel+ 4500 x 600 x 150 T&G2M10-C	3.50kPa Ult load - 1.85kPa Serv load	m2	Each	5	1700
21992	5990	600	150	PowerPanel+ 5990 x 600 x 150 T&G2M10-C	2.80kPa Ult load - 1.10kPa Serv load	m2	Each	5	2075
PowerPanel+ - Made to Order Commercial Wall Panels - Non Cuttable - 100mm & 125mm thick									
MTO 03	up to 4000	600	100	Made to Order PowerPanel+	T&G Profile - 5mm bevel	m2	Each	8	-
MTO 04	up to 6000	600	125	Made to Order PowerPanel+	T&G Profile - 10mm bevel	m2	Each	6	-
PowerPanel+ - Made to Order Commercial Wall Panels - Non Cuttable - 150mm & 300mm thick									
MTO 05	up to 6000	600	150	Made to Order PowerPanel+	T&G Profile - 10mm bevel	m2	Each	5	-
MTO 06	up to 6000	600	175	Made to Order PowerPanel+	T&G Profile - 10mm bevel	m2	Each	4	-
MTO 07	up to 6000	600	200	Made to Order PowerPanel+	T&G Profile - 10mm bevel	m2	Each	4	-
MTO 08	up to 6000	600	250	Made to Order PowerPanel+	T&G Profile - 10mm bevel	m2	Each	3	-
MTO 25	up to 6000	600	300	Made to Order PowerPanel+	T&G Profile - 10mm bevel	m2	Each	3	-

T&G = Tongue & Groove; 2M = Caged; 5 = 5mm Bevel; 10 = 10mm Bevel;

Notes:

1. MTO Widths can vary 300mm to 600mm.

2. Panels are non-cuttable i.e made to length.

3. All Made to Order products are: Made to Confirmed Order Only - Minimum Quants Apply – Lead Times Apply - Engineering Checks Apply.

4. Weight may vary due to moisture content.

5. See glossary at the back of the book for definition of Ult load and Serv load.

ACCESSORIES

Code	Description	Main Application	UoM	Order Unit	Quantity / Unit
PowerPanel Plus - Commercial Wall Accessories					
21933	Hebel Adhesive	All systems	Bag	20kg Bag	1
21935	Hebel Mortar	All systems	Bag	20kg Bag	1
21873	Tension Tie Stainless Steel 125mm panel	Install 125 panel to frame	Each	Each	1
21874	Tension Tie Stainless Steel 150mm panel	Install 150 panel to frame	Each	Each	1
21936	Right Angle Bracket 200mm 3 slots	Connect 125mm or 150mm panels to slab at top & bottom, fixed to rasped tongue side of panel	Each	Each	1
21929	V-Nails	Nail tension tie to panel	Each	Each	1
21960	Panel Scisser Lifter H/zontal 125-200mm	Commercial walls	Each	Each	1
5131442	Hebel Panel Lifting Lug	For custom panels 125 - 300 mm	Each	Each	1
119426	Panel Separator Kit	All systems	Each	Each	1
Cut 1	Cross-Cut standard panels to length	Cut charge - no discount	Each	Each	1
Cut 2	Long-Cut to create a custom panel width	Cut charge - no discount	Each	Each	1

Note: Lifting Lugs & Inserts can be placed within the panel. Please nominate how far from the end these need to be placed. The lifting lugs require a Reid SwiftLift (Green) with a minimum of 1.5 Tonne to lift with. Refer to glossary.

PowerFloor+

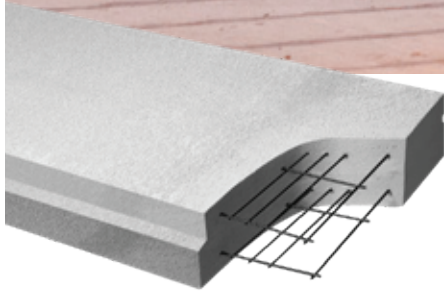

FOR A LOAD-BEARING REINFORCED FLOOR SYSTEM SPANNING UP TO 5.85M WITHOUT FLOOR FRAMING OR JOISTS. ASSISTS IN REDUCING SLABS, COLUMNS AND FOOTINGS.

FLOORS

- APARTMENTS
- COMMERCIAL & INDUSTRIAL

APPLICATIONS

APARTMENTS AND COMMERCIAL & INDUSTRIAL

Floors

- range of thicknesses from 150mm to 250mm
- eliminates need for a joist system or the pouring of concrete
- load bearing span up to 5.85 metres without floor framing or joists
- fire-rating of up to 180 minutes without relying on ceiling systems
- superior thermal efficiency assisting in reduced heating and cooling loads on buildings
- cost efficiencies through speed of installation and minimised structural sizes
- limited propping and no curing of concrete required
- panels can be made to length resulting in less wastage

POWERFLOOR+ FLOOR SYSTEM

The PowerFloor+ system consists of extremely strong panels that fit snugly together to form a smooth and strong floor, without the need to wait for concrete to cure and with limited propping.

The interlocking of the PowerFloor+ panels with grout creates a full fire seal between panels, which – combined with Hebel's fire-resistant properties – means it can achieve Fire Resistance Levels of up to 3 hours without relying on ceiling systems.

Load-bearing and spanning up to 5.85m without floor framing or joists the lightweight nature of system assists in reducing slabs, columns and footings.

Our System Specification Finder helps you find the best system for your next project.

Visit www.hebel.com.au/specification-tool

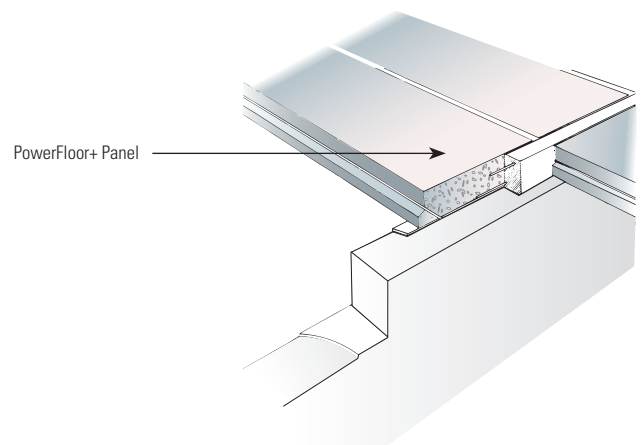

PRODUCT SIZES

Code	Length	Width	Thick	Description	Main Application	UoM	Order Unit	Quantity / Unit
Hebel PowerFloor Plus Panels - Made to Order Commercial Flooring 150mm to 250mm - Non Cuttable								
MTO 11	up to 6000	600	150	Made to Order PowerFloor+	DP Profile	m2	Each	1
MTO 14	up to 6000	600	175	Made to Order PowerFloor+	DP Profile	m2	Each	1
MTO 17	up to 6000	600	200	Made to Order PowerFloor+	DP Profile	m2	Each	1
MTO 20	up to 6000	600	225	Made to Order PowerFloor+	DP Profile	m2	Each	1
MTO 23	up to 6000	600	250	Made to Order PowerFloor+	DP Profile	m2	Each	1

Notes:

1. All Made to Order products are: Made to Confirmed Order Only - Minimum Quants Apply – Lead Times Apply - Engineering Checks Apply.
2. Maximum panel lengths for a given thickness in Commercial Flooring are governed by strict engineering guidelines.
3. To ensure a given thickness or span can be manufactured for a given load and/or FRL please refer to the Hebel Technical Manual - Section 7 Page 16 - Table 7.1.

SoundBarrier



FOR A HIGHLY EFFECTIVE ACOUSTIC WALL SYSTEM TO SIGNIFICANTLY REDUCE NOISE LEVELS FROM INDUSTRY, FREEWAYS AND RAIL CORRIDORS.

SOUND BARRIERS

- INDUSTRY
- MAJOR ROADS
- RAIL CORRIDORS

APPLICATIONS

CIVIL & UTILITIES

Sound barriers

- range of thicknesses from 150mm to 250mm
- extremely cost effective compared to precast concrete, around 30% cheaper
- smaller and quicker footings are installed when compared with other masonry barriers
- light weight system reduces crane sizes, traffic blockages and increases truck utilisation
- fire protection: panels are non-combustible and won't burn.
- wide range of coating colours available and patterns can be routed into the panels to the clients design

SOUNDBARRIER SYSTEM

The standard system consists of galvanised steel columns in concrete pier foundations. The caged steel-reinforced Hebel SoundBarrier panels are placed horizontally between or against the columns and held in place by galvanised steel angles or plates. At just 25% the density of concrete, the system is fast and easy to install and negates the need for costly precast moulds and large craneage associated with pre-cast concrete installations.

The system can be designed to accommodate feature bays or stepped to follow the grade of the road providing an uninterrupted wall of constant height.

Our System Specification Finder helps you find the best system for your next project.

Visit www.hebel.com.au/specification-tool

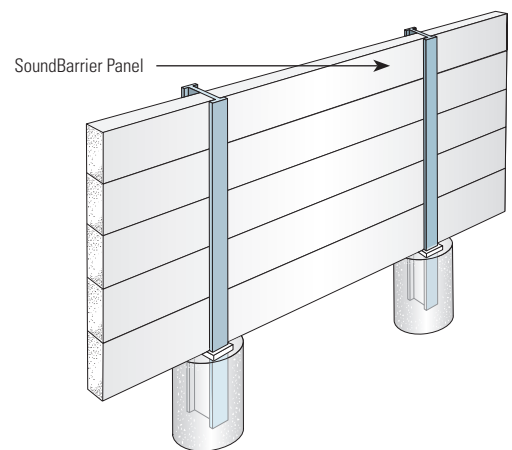

PRODUCT SIZES

Code	Length	Width	Thick	Description	Main Application	UoM	Order Unit	Quantity / Unit	Weight / Pallet
SoundBarrier Panels - 100mm & 125mm - Non Cuttable									
21997	3000	300	100	SoundBarrier 3000x300x100 T&G2M5	2.50kPa Ult load & 1.60kPa Serv load	m2	Each	8	563
21998	4000	300	100	SoundBarrier 4000x300x100 T&G2M5	2.00kPa Ult load & 0.90kPa Serv load	m2	Each	8	789.6
21996	3000	600	100	SoundBarrier 3000x600x100 T&G2M5	2.70kPa Ult load & 1.60kPa Serv load	m2	Each	8	1127
21995	4000	600	100	SoundBarrier 4000x600x100 T&G2M5	2.20kPa Ult load & 0.90kPa Serv load	m2	Each	8	1502.4
38688	4000	300	125	SoundBarrier 4000x300x125 T&G2M10	3.60kPa Ult load & 1.80kPa Serv load	m2	Each	6	696
29174	4000	600	125	SoundBarrier 4000x600x125 T&G2M10	3.60kPa Ult load & 1.80kPa Serv load	m2	Each	6	1386

T&G = Tongue & Groove; 2M = Caged; 5 = 5mm Bevel; 10 = 10mm Bevel.

Notes:

1. Panels are non-cuttable i.e made to length.
2. Weight may vary due to moisture content.

ACCESSORIES

Code	Description	UoM
Hebel Panel Routing - All edges have 45° bevel		
5177590	Standard Routing - Modular 1	m2
5177631	Standard Routing - Modular 2	m2
5177633	Standard Routing - Inflexion Vertical	m2
5177634	Standard Routing - Echelon	m2
5177635	Standard Routing - Echelon	m2
5177632	Standard Routing - Impress	m2
5133794	Custom Routing	m2

ROUTING DESIGN OPTIONS- ALL EDGES HAVE 45° BEVEL.

Modular 1 - 5177590



Echalon 1 - 5177634

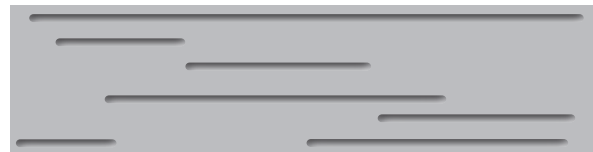

Modular 2 - 5177631



Echalon 2 - 5177635



Inflexion - 5177633

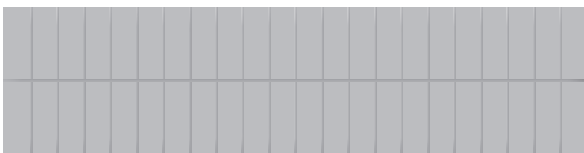

Impress - 5177632



PowerShield



PROVIDES HIGH PERFORMING FIRE AND ACOUSTIC WALL SOLUTIONS TO PROTECT INFRASTRUCTURE ASSETS.

FIRE & ACOUSTIC WALL

- POWER STATIONS
- SUBSTATIONS
- TUNNELS

APPLICATIONS

CIVIL & UTILITIES

Fire walls

- range of engineering systems developed specifically for the power, roads and tunnel infrastructure industries
- used for tunnel linings and substation enclosures
- hydrocarbon fire performance up to 2 hours*
- cellulosic fire performance from -/120/120 to -/240/240 depending on system
- easy to install where there is restricted site access
- doesn't require heavy lifting equipment – distinct advantaged compared with requirements for pre-cast concrete

Acoustic / firewalls

- provides same advantages of PowerPanel+ Fire Wall Systems with the addition of an advanced tunable sound reduction system
- delivers a resonant frequency barrier under 150HZ, far lower than other traditional alternatives
- can eliminate resonant noise at a close distance from the source, providing opportunity to utilise adjacent land otherwise unsuitable for development

* when exposed to the Hydrocarbon Modified (HCM) curve (Exova Warringtonfire Fire Assessment 28255-04 RIR).

FOR DEATILS ON POWERSHIELD SYSTEMS VISIT HEBEL.COM.AU

FIRE & ACOUSTIC WALLS

The PowerShield Acoustic Absorption Wall System is constructed with horizontal, steel reinforced tongue and groove PowerShield panels mounted to vertical steel columns in concrete foundations. A second skin of 75mm PowerPanel is connected to the PowerShield wall using steel top hats. These panels have a calculated horizontal and vertical air gap between them, acting as slats which face the noise source. The positioning of these panels can be adjusted to address specific resonant frequency of the project.

Our System Specification Finder helps you find the best system for your next project.

Visit www.hebel.com.au/specification-tool

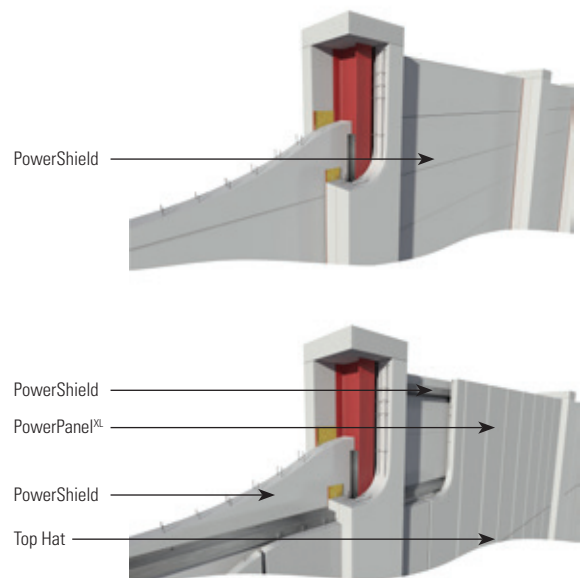

POWERSHIELD

PRODUCT SIZES

Code	Length	Width	Thick	Description	UoM	Order Unit	Quantity / Unit	Weight / Pallet	
PowerShield PowerPanel^{XL}									
118014	PowerPanel ^{XL} 2400 x 600 x 75 SQ1M0			Internal & external walls	m2	Pack	10	605	
PowerShield Panels - Made to Order									
MTO 26	up to 6000	600	150	PowerShield 150mm	T&G Profile - 10mm bevel	m2	Pack	5	-
MTO 27	up to 6000	600	175	PowerShield 175mm	T&G Profile - 10mm bevel	m2	Pack	4	-
MTO 28	up to 6000	600	200	PowerShield 200mm	T&G Profile - 10mm bevel	m2	Pack	4	-
MTO 29	up to 6000	600	250	PowerShield 250mm	T&G Profile - 10mm bevel	m2	Pack	3	-
MTO 30	up to 6000	600	300	PowerShield 300mm	T&G Profile - 10mm bevel	m2	Pack	3	-

SQ = Square Edge; 1M = Single Mesh; 0 = No Bevel; T&G = Tongue & Groove.

Notes:

1. Panels are non-cuttable i.e made to length.
2. Weight may vary due to moisture content.
3. All Made to Order products are: Made to Confirmed Order Only - Minimum Quants Apply – Lead Times Apply - Engineering Checks Apply.

ACCESSORIES

Code	Description	UoM	Order Unit	Quantity / Unit		
Adhesives and Coatings						
21933	Hebel Adhesive	All systems	Bag	20kg Bag	1	5
122116	CSR Fireseal - Fire & Acoustic Sealant	All systems	Box	Box	12	4

Note: CSR FireSeal - Fire & Acoustic Sealant - Coverage: 6 lineal meters per sausage.

Glossary

Product Profiles

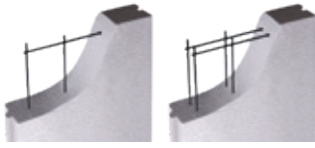

Single Mesh & Caged



Square edge



Tongue & Groove



Off Set Tongue & Groove (Applies to 100mm only)



DP profile - Caged (Applies to PowerFloor+)

Hebel Panel descriptions

XL	XL (PowerPanel ^{XL}) refers to density. XL is lower density than standard PowerPanel, therefore lighter in weight. Used in low rise residential construction
Mesh / Caged Panels	Panels are reinforced with a caged steel mesh. There may be 1 or 2 within a panel. 1M = Single Mesh 2M = Double Mesh referred to as "Caged"
Square edge	Square edge is applied to PowerPanelXL and PowerPanel
Bevel	Typically applied to the edges of PowerPanel+ panels - available in 75mm = no bevel, 100mm = 5mm bevel, 125mm+ = 10mm bevel
Tongue and groove (T&G)	Tongue and groove or T&G is applied to PowerPanel, PowerPanel+ and PowerFloor It is typically centred
DP	This profile is applied to PowerFloor+ panels
Routing	We have a range of designs available or you may provide your own design. CSR Hebel requires submission of the routing design in CAD dwg file format
Cuttable	Some panels may be cut shorter at either end of the panel. 75mm panel (excluding PowerFloor) can be cut to a minimum of 5mm and a maximum of 30mm from each end. For 100mm thick panel and over, consult an engineer before cutting

Commonly used building terms

C & U - track	Deflection Head - used in high rise construction
Top Hat / Battens	24mm, 35mm or 75mm Top Hat sections for low rise (PowerPanel ^{XL}) external walls and 50mm Top Hat sections for high rise façade
L Track - Bottom angle	50 x 50 x 0.8mm BMT base angle (Code 21938) used for high rise intertenancy walls
L Track - Top angle	75 x 50 x 1.2mm BMT slotted angle (Code 21957) for high rise intertenancy walls
BMT	Base Metal Thickness

Basic Screw definitions

Screw descriptions have three numbers. The first number indicates the gauge of the screw, the second the threads per inch & the third indicates the shaft length. Following this is a description of the head type and tip.
Eg Screw 14 – 10 x 65 HexHead Type 17

Hex Head



Hexagonal shape

Bugle Head



A smooth curved surface under the head face. Used for external fixing of panels. Should not be used on PowerPanel^{XL}

Type 17



Generally used for drilling and fastening to timber

Teks



Generally used for drilling and fastening to steel

FRL - Fire Rating Level

CSR Hebel will not determine FRL - these are to be advised by project consultants or qualified structural engineer

FRL (Fire Rating Level) made up of three numbers - Structural Adequacy/Integrity/Insulation - expressed in minutes i.e 60/60/60.
Be sure to confirm if fire source is above or below floor/ ceiling/ roof panel

Structural Adequacy	Capacity of a system or element to bear load during a fire
Integrity	Capacity of a system or element to restrict the passage of flame and hot gases during a fire
Insulation	Capacity of a system or element to restrict the temperature rise on the non-fire side of a wall or floor element during a fire

Wind Pressure

Wind pressure considers shielding, topography, wind direction etc.

CSR Hebel will not determine wind pressures - these are to be advised by project consultants or qualified structural engineer

kPa	Is defined as the applied force (in kN) over a square metre (m ²) i.e kN	
Walls	Service Load	Wind Pressure experienced at regular intervals i.e 1 in 5 years, 1 in 20 years etc. This must be determined by a qualified structural engineer
	Ultimate Load	Wind Pressure experienced in ultimate or extreme conditions i.e cyclones, hurricanes etc. over a longer re-occurrence interval i.e 1 in 100 years. This must be determined by a qualified structural engineer. Note: wind pressures are greater at building corners or at the ends for free standing walls.
Floors	Live Load	Variable loads applied to a structure ie, people, furniture (eg: pool table, piano)
	Dead Load	Permanent loads applied to a structure ie, self weight of the structure or system (eg: internal walls)

Hebel PowerPanel Lifting Lugs

Lifting Lug

PowerPanel+ 125 – 300mm can be custom made with a lifting lug.



Lifting clutch:

The Reid SwiftLift (Green) with 1.5-Tonne load capacity is the only method of attachment to the lug. This is available through large building supply companys. CSR Hebel does not carry the SwiftLift.

Accessories

Code	Description	Main application	Selling unit	PowerBlock+	PowerPanel ^{KL}	PowerPanel ⁵⁰	PowerPanel	PowerPanel+	PowerFloor	PowerFloor+	PowerFence	PowerShield	SoundBarrier
Adhesives and Coatings													
	21933	Hebel Adhesive	All systems	20kg Bag	■	■	■	■	■	■	■	■	■
	21935	Hebel Mortar	All systems	20kg Bag	■	■	■	■	■				
	21949	Hebel Patch	All systems	10kg Bag	■	■	■	■	■		■		
	25594	Hebel Anti - Corrosion Paint 500ml	Used to coat exposed reo	Each		■	■	■	■	■	■	■	■
	111161	Hebel Base Sealer 5L	Waterproofing for residential	Each	■	■	■						
	122116	CSR FireSeal - Fire & Acoustic Sealant	All systems	Box of 12		■	■	■					■
Deflection Heads, Brackets, Angles and Bead													
	21936	Right Angle Bracket 200mm 3 slots	Connect 125mm or 150mm panels to slab at top & bottom, fixed to rasped tongue side of panel	Each				■					
	21882	Deflection Head 76mm x 50mm x 3m x 0.8mm BMT	Deflection Head for 75mm panel	Each		■						■	
	176867	Deflection Head 51mm x 3m x 0.7mm BMT	50mm Party Wall Base - Residential Connection				■						
	40900	Aluminium Party Wall Bracket	Attach PowerPanel ^{KL} and PowerPanel ⁵⁰ to int. frame	Each		■	■						
	178847	Corner Shelf Angel Bracket	Base support for PowerPanel at external corners - High-rise facades					■					

Accessories

Code	Description	Main application	Selling unit	PowerBlock+	PowerPanel ^{KL}	PowerPanel ⁵⁰	PowerPanel	PowerPanel+	PowerFloor	PowerFloor+	PowerFence	PowerShield	SoundBarrier
Deflection Heads, Brackets, Angles and Bead - Continued													
	21938	Slotted Base Angle 50mm x 50mm x 2.4m x 0.8mm BMT	Base support for int. h/rise walls	Each				■					
	21957	Slotted Angle 75mm x 50mm x 2.7m x 1.2mm BMT	Head support angle	Each	■		■						
	21929	V-Nails	Nail tension tie to panel	Each				■					
	110203	Hebel Direct Fixing Clip	Residential zero boundary wall clips to use with PowerPanel ⁷⁵	Each	■								
	168120	Hebel Direct Fixing Clip - (Exclusive to Hebel Dual Zero Boundary Wall clips) - 200 / box	Attaching top hat for 50mm Intertenancy System				■						
	193703	Rondo Clip 314	For attaching RONDO 301 16mm batten to structural stud frame - Dual Zero Boundary Wall				■						
	106883	Aluminum Render Bead 3m x 70mm x 0.8mm	For horizontal control joints	Each	■								
	126323	Shelf Angle 150mm x 100mm x 3m x 6mm BMT	Base support for PowerPanel	Each				■					
General Purpose Screws													
	21900	Screw 14-10 x 65 mm Hex Head Type 17	Int. fix PowerPanel to TopHat	Box of 500		■	■						
	21906	Screw 10-16 x 16mm Hex Head Tek	Fix TopHat to steel stud frame	Box of 1000		■	■						
	163902	Screw 14-10 x 65mm Bugle Head	Ext. fix PowerPanel ⁵⁰ to TopHat	Box of 500			■						
	41235	Screw 14-10 x 100mm Bugle Head	Ext. fix PowerPanel to TopHat	Box of 250			■		■				
	44174	Screw 14-10 x 150mm Hex Head Type 17	Screw panels together at corners	Box of 250		■	■						
	106882	Screw 12-11 x 35mm Hex Head Type 17	Fix TopHat to timber frame	Box of 500		■							
	125747	Screw 14-10 x 90mm Hex Head Type 17	Ext. fix PowerPanel to TopHat	Box of 250		■							

Accessories

Code	Description	Main application	Selling unit	PowerBlock+	PowerPanel ^{KL}	PowerPanel ^{ISO}	PowerPanel	PowerPanel+	PowerFloor	PowerFloor+	PowerFence	PowerShield	SoundBarrier
Hand Tools													
	21892	Levelling Plane	Levelling Hebel blocks	Each	■								
	21901	PowerPanel Lifters 16mm	Handling system for PowerPanel	One Pair	■		■						
	21903	PowerPanel Trolley 2.4-2.7 panels	Handling system for PowerPanel	Each				■					
	21904	PowerPanel Trolley 2.9-3.35 panels	Handling system for PowerPanel	Each				■					
	130324	Installer PowerPanel Trolley	Handling system for PowerPanel	Each	■		■						
	162645	2 Wheel Panel Mover	Handling system for PowerPanel	Each	■		■						
	21912	Sanding Float	All systems	Each	■	■	■	■	■	■	■	■	■
	21928	Trowel 75mm	All systems	Each	■	■	■	■	■	■	■	■	■
	107687	Panel Scissor Lifter	Panel lifter	Each		■							
	119426	Panel Separator Kit	All systems	Each				■					









Accessories

Code	Description	Main application	Selling unit	PowerBlock+	PowerPanel ^{KL}	PowerPanel ^{ISO}	PowerPanel	PowerPanel+	PowerFloor	PowerFloor+	PowerFence	PowerShield	SoundBarrier
Hand Tools													
	21960	Panel Scisser Lifter H/zontal 125-200mm	Commercial walls	Each				■					
	5131442	Hebel Panel Lifting Lug	For custom panels 125 - 300 mm	Each				■					
Hebel Routing													
	5177590	Standard Routing - Modular 1		m2									■
	5177631	Standard Routing - Modular 2		m2									■
	5177634	Standard Routing - Echelon 1		m2									■
	5177635	Standard Routing - Echelon 2		m2									■
	5177633	Standard Routing - Inflexion		m2									■
	5177632	Standard Routing - Impress		m2									■

Accessories

Code	Description	Main application	Selling unit	PowerBlock+	PowerPanel ^{KL}	PowerPanel ^{ISO}	PowerPanel	PowerPanel+	PowerFloor	PowerFloor+	PowerFence	PowerShield	SoundBarrier
PowerFence													
	79616	PowerFence Post Extension Piece 800mm	PowerFence	Each							■		
	82297	Screw 10-24 x 40mm Self Drilling	PowerFence	Box of 250							■		
	82299	PowerFence Post Cover 240 x 1800 x 15mm	Vertical express FC post cover	Each							■		
	82300	PowerFence Post Cover 115 x 1800 x 15mm	Vertical express FC post cover	Each							■		
	124983	Hebel Capping Pack	Hebel capping block 600 x 200 x 50	Pack of 6							■		
	131883	PowerFence Post	PowerFence	Each							■		
	133341	PowerFence Bracket Set	PowerFence	Each							■		
PowerFloor Screws													
	41235	Screw 14-10 x 100mm Bugle Head	Ext. fix PowerPanel to TopHat	Box of 250			■		■				
	29041	Screw 14-10 x 95mm Hex Head	Fix PowerFloor to steel joist	Box of 500					■				

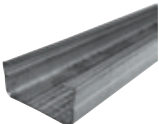
Accessories

Code	Description	Main application	Selling unit	PowerBlock+	PowerPanel ^{XL}	PowerPanel ⁵⁰	PowerPanel	PowerPanel+	PowerFloor	PowerFloor+	PowerFence	PowerShield	SoundBarrier
Tension Ties													
	21873	Tension Tie Stainless Steel 125mm panel	Install 125 panel to frame	Each				■					
	21874	Tension Tie Stainless Steel 150mm panel	Install 150 panel to frame	Each				■					
Top Hats & Batten													
	21909	Perforated TopHat 24mm x 4.8m x 0.42mm BMT	Attaching PowerPanel ^{XL} and PowerPanel ⁵⁰ to frame	Each	■	■							
	168890	Perforated TopHat 45mm x 4.8m x 0.48mm x 0.48mm x 0.42 BMT	Attaching PowerPanel ^{XL} to frame	Each	■								
	24092	TopHat 75mm x 4.8m x 0.70mm BMT	Attaching PowerPanel ^{XL} to frame	Each	■								
	105536	Perforated TopHat 35mm x 4.8m x 0.55mm BMT	Attaching PowerPanel ^{XL} and PowerPanel ⁵⁰ to frame	Each	■	■							
	141233	TopHat 50mm x 4.8m x 0.75mm BMT	Attaching PowerPanel to frame	Each				■					
	192101	RONDO 301 Batten 16mm x 4.8m x 0.42 BMT	Fixing PowerPanel ⁵⁰ to the structural support framing using the RONDO 314 Direct Fix Clip	Each				■					
Fireseal													
	182233	Fireseal Damper Strip 15/Pack 750mm long x 225mm wide x 13mm thick	Horizontal Control Joint					■					
	193379	Fireseal Party Wall Sealer 4000mm x 300mm x 50mm	Used as a sealer between panel and roof / wall cavities					■					



CSR HEBEL
Trinity 3, 39 Delhi Road
North Ryde NSW 2113, Australia
Telephone +61 2 9235 8000

Health & safety

Information on any known health risks of our products and how to handle them safely is on product packaging and / or the accompanying documentation. Additional information is listed in the Material Safety Data Sheet (MSDS). To obtain a copy of a MSDS, download from www.hebel.com.au. Contractors are required by law to perform their own risk assessments before undertaking work.

Performance & certification

Hebel® products and systems are developed in Australia by CSR Building Products. ABN. 55 008 631 356. It is a manufacturer and supplier of Hebel Autoclaved Aerated Concrete (AAC) products. Because it is a manufacturer and supplier only, CSR does not employ people qualified as Accredited or Principal Certifiers.

CSR is therefore unable to provide Construction Compliance Certificates or Statements of Compliance. CSR conducts appropriate testing of its products and systems to determine performance levels. These include structural, fire and acoustic tests. Testing is conducted and certified by appropriate specialists in these fields. When using Hebel products and systems in specific projects, such specialists should be consulted to ensure compliance with the Building Code of Australia and relevant Australian Standards.

Disclaimer

Information presented in this document is supplied in good faith and to the best of our knowledge was accurate at the time of preparation. The provision of this information should not be construed as a recommendation to use any of our products in violation of any patent rights or in breach of any statute or regulation. Users are advised to make their own determination as to the suitability of this information in relation to their particular purpose or specific circumstances. Since the information contained in this document may be applied under conditions beyond our control, no responsibility can be accepted by CSR, or its staff for any loss or damage caused by any person acting or refraining from action as a result of misuse of this information.

Other

The design of a wall, floor or fence system requires the services of professional consultants. This document has been prepared as a source of information to provide general guidance to those consultants – and in no way replaces the services of the professional consultant and relevant engineers designing the project.

No liability can therefore be accepted by CSR or other parties for the use of this document. Hebel products and systems undergo constant research and development to integrate new technology and reflect ongoing performance enhancement.

Hebel systems are constantly reviewed so as to reflect any changes in legislative building requirements and or general developments in common building practice, due to our commitment to continual development and improving our building systems.

We advise that all users of this document should regularly check that this document is current, and they are applying our latest design information.

The latest editions of our documents are available on our website:
www.hebel.com.au

Hebel® is a registered trademark of the Xella group. CSR Building Products Ltd is an exclusive licensee of Xella. CSR Hebel is a business of CSR Building Products Ltd ABN 55 008 631 356.

PowerPanel®, PowerBlock®, PowerFloor®, PowerShield®, PowerFence® and SoundBarrier™ are registered trademarks of CSR Building Products Limited.

The better way to build

Hebel is a quality building product, and is backed by CSR Building Products Limited.

For more information visit our website:

www.hebel.com.au

For sales enquiries or further information, please telephone us from anywhere in Australia:

1300 369 448

