

High Rise Apartments Student Accommodation Hotels and Commercial

CORRIDOR, INTERTENANCY,
SHAFT & SERVICE WALLS

DESIGN AND INSTALLATION GUIDE



CONTENTS

This Design and Installation Guide has been prepared as a source of information to provide general guidance to consultants – and in no way replaces the services of the professional consultant and relevant engineers designing the project.

When preparing this document the most up-to-date standards and codes were used. However CSR Hebel cannot guarantee that these standards and codes are currently used or applicable in your state or territory.

It is the responsibility of the architectural designer and engineering parties to ensure that the details in this Design and Installation Guide are appropriate for the intended application.

The recommendations of this guide are formulated along the lines of good building practice, but are not intended to be an exhaustive statement of all relevant data.

Why Hebel® systems are a better way to design and build	1
1. Design and selection detail	
1.1 Applications overview	3
1.2 Intertenancy Wall <i>concealed water services one side</i>	4
1.3 Intertenancy Wall <i>concealed water services both sides</i>	5
1.4 Intertenancy Wall <i>large concealed water services both sides</i>	6
1.5 Corridor Wall <i>concealed water services one side</i>	7
1.6 Corridor Wall <i>concealed water services one side with furring channel</i>	8
1.7 Shaft Wall <i>adjacent to wet or common areas</i>	9
1.8 Shaft Wall <i>adjacent to dry habitable rooms</i>	10
1.9 Services Wall <i>for walls up 3.3 metres high</i>	11
1.10 Services Wall <i>for walls with 2 hour fire rating up to 4.65 metres high</i>	12
1.11 System components	13
2. System performance	
2.1 Acoustic performance	17
2.2 Fire rating performance	18
2.3 Structural performance	19
3. Installation detail	
3.1 Installation flowchart	20
3.2 Installation	22
3.3 Design & installation considerations	24
3.4 Coatings	25
3.5 Construction details overview	26
3.6 Construction details: FRL up to -/90/90	27
3.7 Construction details: FRL up to -/120/120	33
4. Handling, storage and responsibility	
4.1 Delivery and storage	36
4.2 Panel handling	37
4.3 Design, detailing and performance responsibilities	38
5. Appendix	
5.1 Appendix 1: Hebel PowerPanel material properties	39

WHY HEBEL® SYSTEMS ARE A BETTER WAY TO DESIGN AND BUILD



Whether you're a developer, architect, designer, builder or wall installer, Hebel wall systems deliver exceptional advantages in terms of quality, project efficiency, risk minimisation and cost and time certainty.

Creating high performance buildings using Hebel PowerPanel

At the heart of the Hebel internal wall systems is the Hebel PowerPanel, a 75mm thick steel reinforced masonry building panel made from autoclaved aerated concrete (AAC).

Developed and warranted by CSR, the Hebel PowerPanel can reduce heating and cooling loads on buildings, is non-combustible, can be produced to the size needed, is easily cut, makes construction fast and efficient, creates minimal waste and is a better choice for the environment compared with concrete or brick.

Using the 'solid wall' advantage in developments

There's a very good reason why Australia's largest apartment developers want Hebel wall systems. They can increase market potential and return for a minimal initial investment.

Hebel walls feel solid when you knock on them, can't be cut through with a knife and overall provide a quality long-term investment. And for builder / developers the benefits are doubled with fast construction and minimised risk.

Maximising floorspace

Hebel wall systems have been developed with floorspace in mind. The intertenancy wall system for concealed services on one side is one of the narrowest system on the market at just -185mm wide. This means greater design flexibility and more gross sellable floor space.

Benefiting from product versatility

The Hebel PowerPanel is used across the full range of internal wall systems - intertenancy, corridor, shaft and service walls – as well as balcony blades and facades. Each stage of a project benefits from this versatility – in design, estimating, procurement, delivery, handling, installation and certification.

This versatility also applies to wall heights and fire-rating levels. At its base system level the single mesh tongue and groove PowerPanel is suitable for applications with fire ratings up to 90 minutes for wall heights to 3.3 metres. When higher fire ratings

up to 2 hours for vertical wall heights up to 4.65 metres are needed, caged tongue and groove PowerPanel steps in.

What's more, PowerPanel caged tongue and groove can be installed horizontally to a maximum panel length of 4800mm and to an unlimited height without the need for thin bed adhesive at the panel joints.

Design efficiency, quality and risk minimisation

Hebel wall systems cut through complexity in specifying internal walls. The systems are simple and only two types of plasterboard lining need to be considered for each system – standard or moisture resistant. This streamlines the design process and minimises the potential for error.

Further, system referencing and access to quality technical support is easy and efficient through the one reliable and trusted source, CSR Hebel.

Overall, the Hebel wall systems enable architects and designers to be confident in specifying a quality solution that's robust, proven, tested, fast and efficient to install and value-adding in terms of solidity and security.



Hebel PowerPanel single mesh tongue & groove profile



Hebel PowerPanel caged tongue & groove profile

Greater control over construction schedules and costs

Hebel internal walls systems go up quickly and easily which is why so many developers and construction companies rely on them to keep control of their project schedule and costs.

Builders are already ahead on their project when they specify Hebel systems. Delivery of the Hebel PowerPanels and installation of the Hebel wall leaves isn't held up waiting for windows to go in as wet or damp conditions don't affect the PowerPanel wall leaf installation.

Then there's the simplicity of the systems, which help maximise construction efficiency and minimise costs. For example:

- PowerPanels can be ordered to length for easy installation with minimal waste
- small number of material types reduces logistical complexity before and during construction
- the Hebel PowerPanel wall leaf is the fire-rated element making compliance easy
- service penetrations installation and compliance is easy, with minimised rework
- plasterboard linings aren't required to go past the ceiling for NCC fire-rating compliance
- ceiling frames can be installed either before or after linings
- one trade can install the whole wall system.

Another significant speed and efficiency saving is in the installation of GPOs and dampers. The Hebel systems don't require fire-rated GPOs and dampers are connected to Hebel PowerPanel wall leaf only.

Constructing with Hebel internal wall systems means logistics are simple, the number of trades is minimised, work flows easily, project schedules are controlled, cost certainty is enhanced and risk is minimised.

Minimising risk

Hebel wall systems provide a solid foundation for risk minimisation in design and construction.

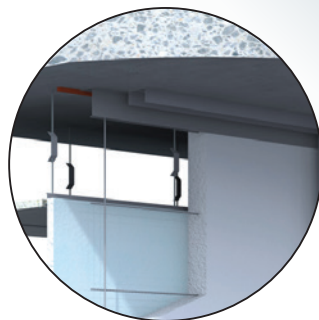

The Hebel Express Head system simplifies design and construction and minimises risk. The Hebel PowerPanel is installed from slab to soffit with only one fire sealant position required at head.

They are tested, well proven and designed to achieve NCC fire and acoustic rating compliance easily. Combining the non-combustible property of the Hebel PowerPanel with advanced system designs, CSR Hebel delivers high value cost effective solutions that significantly reduce the number of fire and acoustic risk points in construction.

Gaining high sustainability values

Hebel AAC is a durable inert product, made from raw materials in a process that minimises embodied energy. The low bulk density of Hebel AAC means less than a quarter of the resources in raw materials are used in its production than for concrete and bricks.

Waste in production is reduced through extensive recycling. Production waste, slurry and even the steam generated are all recycled back into the manufacturing process while waste steel and oil are recycled off site. Even the non-toxic citrus based solvents used for cleaning are recycled. On site the combination of panel sizes designed to suit standard building modules and the ease of working with standard power tools means there is very little waste. This goes a step further when panels are made-to-order.

Altogether, Hebel is one of the most environmentally responsible building materials for wall system construction.

Leveraging the exceptional value-add of Hebel systems

Quite simply Hebel internal wall systems deliver a holistic solution that no other systems can match. They benefit all stakeholders in the project lifecycle through their role in value-adding to the project's quality, design and construction efficiency, risk minimisation and cost and time certainty.

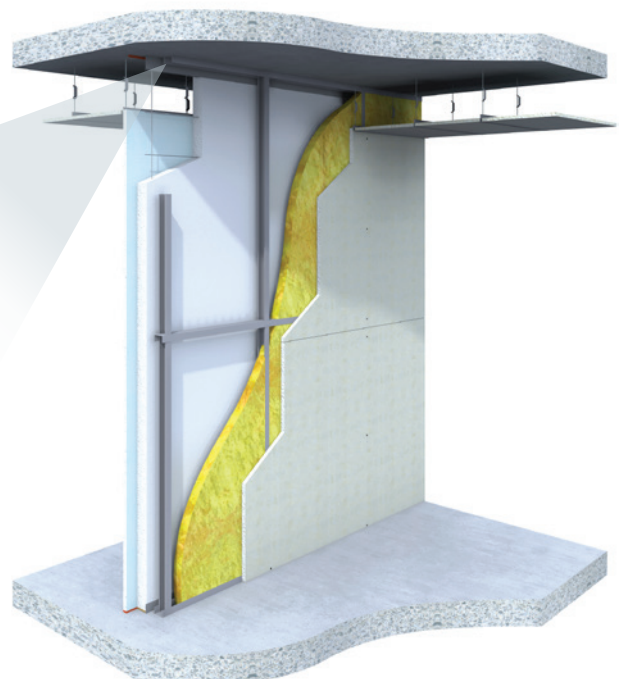

1.1 APPLICATIONS OVERVIEW

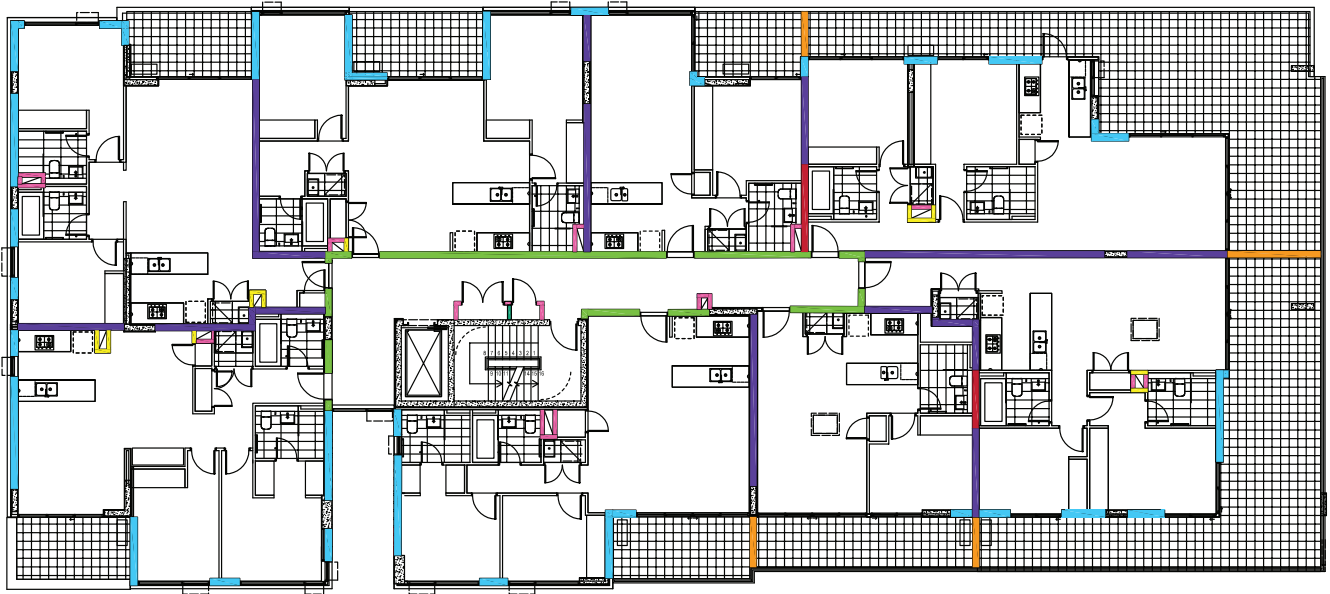

Intertenancy wall - dry to dry / wet

Designed for concealed services on one side using lightweight steel-reinforced PowerPanel, these Hebel Intertenancy Wall Systems provide a solid secure wall that maximises floor space, minimises costs and risks and delivers long-term value.



Shaft wall - wet areas

Hebel Shaft Wall Systems are designed for general partitions between service shafts and wet areas or shafts adjacent to common areas. Constructed with Hebel PowerPanel to maximise floor space and minimise risks and costs.



Intertenancy wall - dry / wet to dry / wet

These Hebel Intertenancy Wall Systems are the ideal solution where there are concealed services on both sides including large services applications such as shower mixers in both apartments. This quality solution using solid and secure PowerPanel maximises floor space and minimises risks and costs.



Service wall - plant rooms

Single mesh or caged Hebel PowerPanel is used in the Hebel Service Wall Systems to isolate and secure plant rooms from other areas of the building. For tall shaft risers with fire ratings up to 2 hours, PowerPanel can be installed horizontally to an unlimited height without the need for thin bed adhesive at the panel joints. Solid and secure, these systems maximise floor space and minimise costs and risks.



Corridor wall

Hebel Corridor Wall Systems maximise floor space and provide a solid secure wall for services located on one side between common areas and apartments.



Balcony Blade

Hebel PowerPanel is used for separating walls between balconies of different sole occupancy units. Refer to High Rise Facades Design & Installation Guide.



Shaft wall - dry areas

Robust and proven Hebel Shaft Wall Systems provide a solid, secure wall with a narrow width around service shafts to dry habitable areas and between scissor stairs. Uses Hebel PowerPanel to maximise space utilisation and minimise risks and costs in high rise and multi-residential construction.



External facade wall

Hebel PowerPanel is used for external façade walls with hidden or visible beams. This lightweight product provides substantial cost savings compared to traditional masonry. Refer to High Rise Facades Design & Installation Guide.



1.2 INTERTENANCY WALL

concealed water services one side

Slotted angle 75mm x 50mm
x 1.2mm BMT

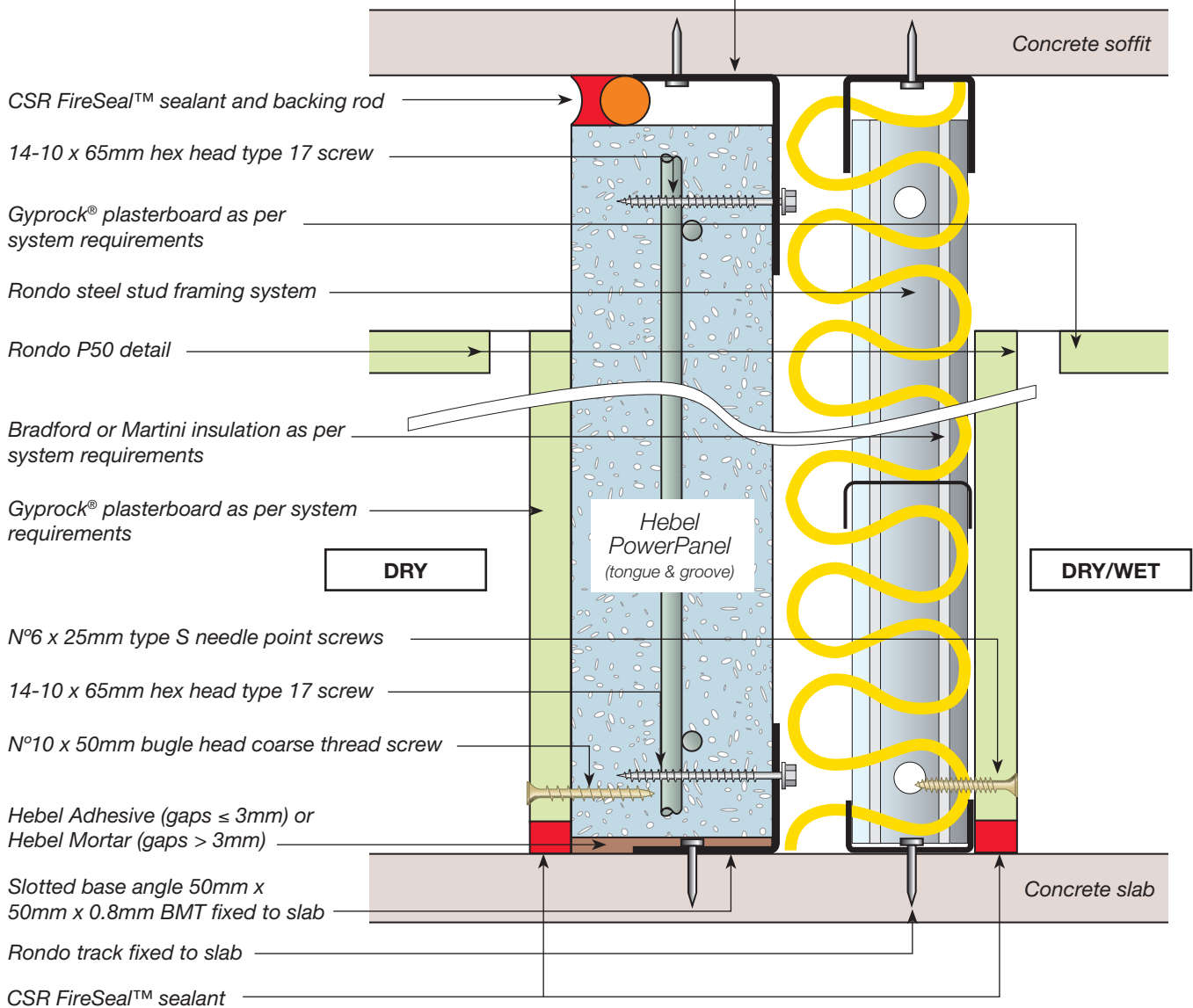

System	Application	FRL ^(A)	Wall linings ^(D)	Cavity width (mm)	Insulation	Acoustic rating Rw+Ctr ^(C)	Wall width (mm)
HEB 1072	Dry to Dry	-/90/90 for wall heights up to 3.3m	Both Sides 13mm Gyprock CD	20	75mm Bradford Acoustigard 11 or 75mm Martini Prime	50	185
HEB 1073	Dry to Wet		Hebel Side – 13mm Gyprock CD Stud Side – 13mm Aquacheck ^(B)				

NOTES:

- (A) For wall heights higher than 3.3m, caged tongue & groove PowerPanel can be used and will achieve a FRL of -/120/120 for wall heights up to 4.65m (vertically). Also see Construction details section.
- (B) 13mm Aquacheck can be replaced by 9mm FC Sheeting and achieve the same Acoustic & Fire Rating Levels.
- (C) Rw+Ctr values are based on acoustic opinion 20140366.9/1606A/R8/GW provided by Acoustic Logic Consultancy Pty Ltd.
- (D) The minimum mass of plasterboard must be 8.5kg/m².

GENERAL NOTES:

- 1. Intertency wall systems HEB 1072-1073 meet NCC 2016 deemed-to-satisfy discontinuous construction requirements.
- 2. HEB 1072-1073 are designed to resist a maximum ultimate lateral pressure of 0.50kPa. Contact Hebel Technical Services if lateral pressures exceed 0.50kPa.



1.3 INTERTENANCY WALL

concealed water services both sides

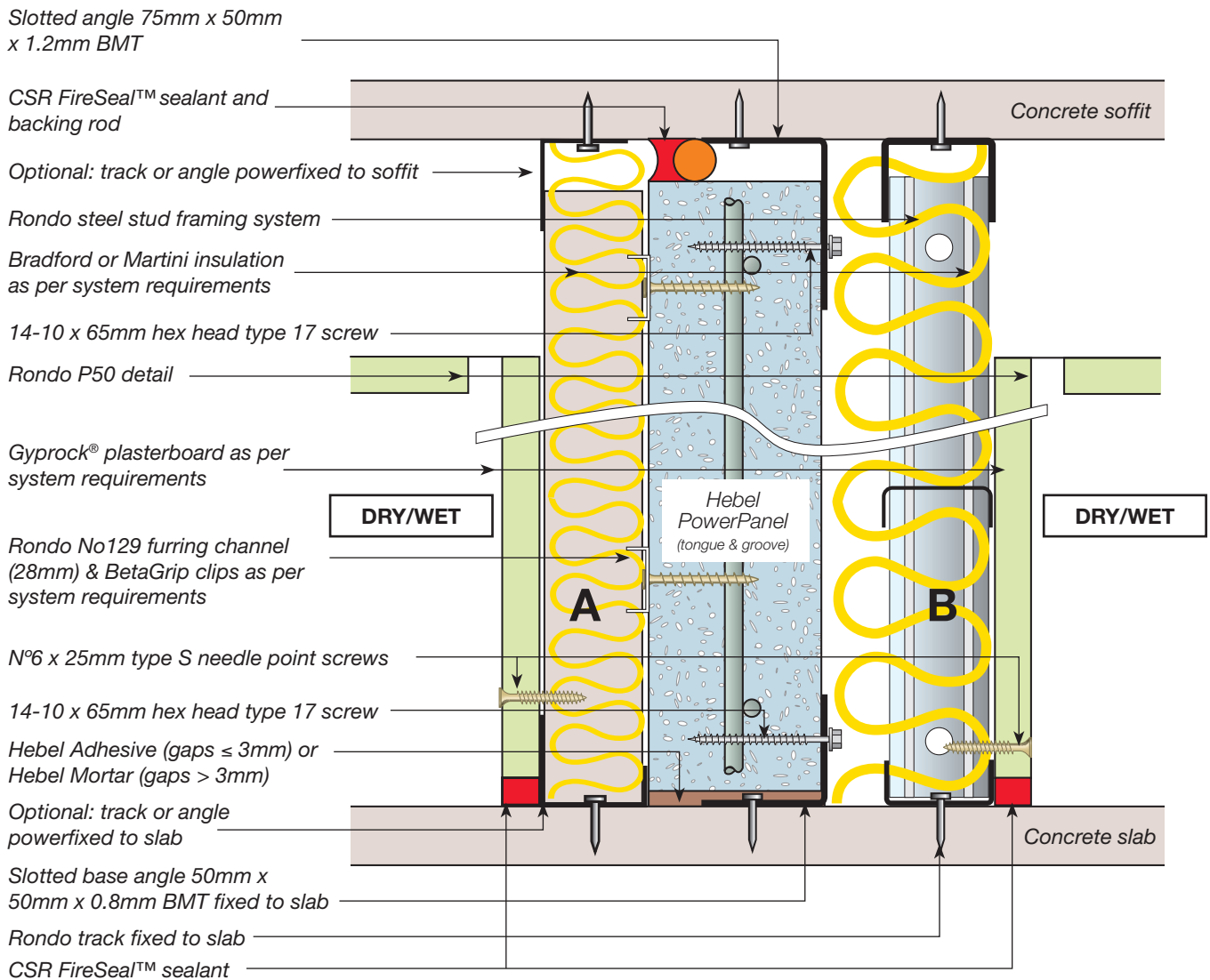

System	Application	FRL ^(A)	Wall linings ^(D)	Insulation A	Cavity width (mm)	Insulation B	Acoustic rating Rw+Ctr ^(C)	Wall width (mm)
HEB 1074	Dry to Dry	-/90/90 for wall heights up to 3.3m	Both Sides 13mm Gyprock CD	50mm Bradford Acoustigard	35	75mm Bradford Acoustigard	50	243
HEB 1075	Dry to Wet		Dry Side – 13mm Gyprock CD Wet Side – 13mm Aquacheck ^(B)	11 or 50mm Martini Prime	20	11 or 75mm Martini Prime	50	228
HEB 1076	Wet to Wet		Both Sides 13mm Aquacheck ^(B)			50	228	

NOTES:

(A) For wall heights higher than 3.3m, caged tongue & groove PowerPanel can be used and will achieve a FRL of -/120/120 for wall heights up to 4.65m (vertically). Also see Construction details section.

(B) 13mm Aquacheck can be replaced by 9mm FC Sheeting and achieve the same Acoustic & Fire Rating Levels.

(C) Rw+Ctr values are based on acoustic opinion 20140366.9/1606A/R8/GW provided by Acoustic Logic Consultancy Pty Ltd.

(D) The minimum mass of plasterboard must be 8.5kg/m².

GENERAL NOTES:

1. Intertency wall systems HEB 1072-1073 meet NCC 2016 deemed-to-satisfy discontinuous construction requirements.
2. HEB 1074-1076 are designed to resist a maximum ultimate lateral pressure of 0.50kPa. Contact Hebel Technical Services if lateral pressures exceed 0.50kPa.



1.4 INTERTENANCY WALL

large concealed water services both sides

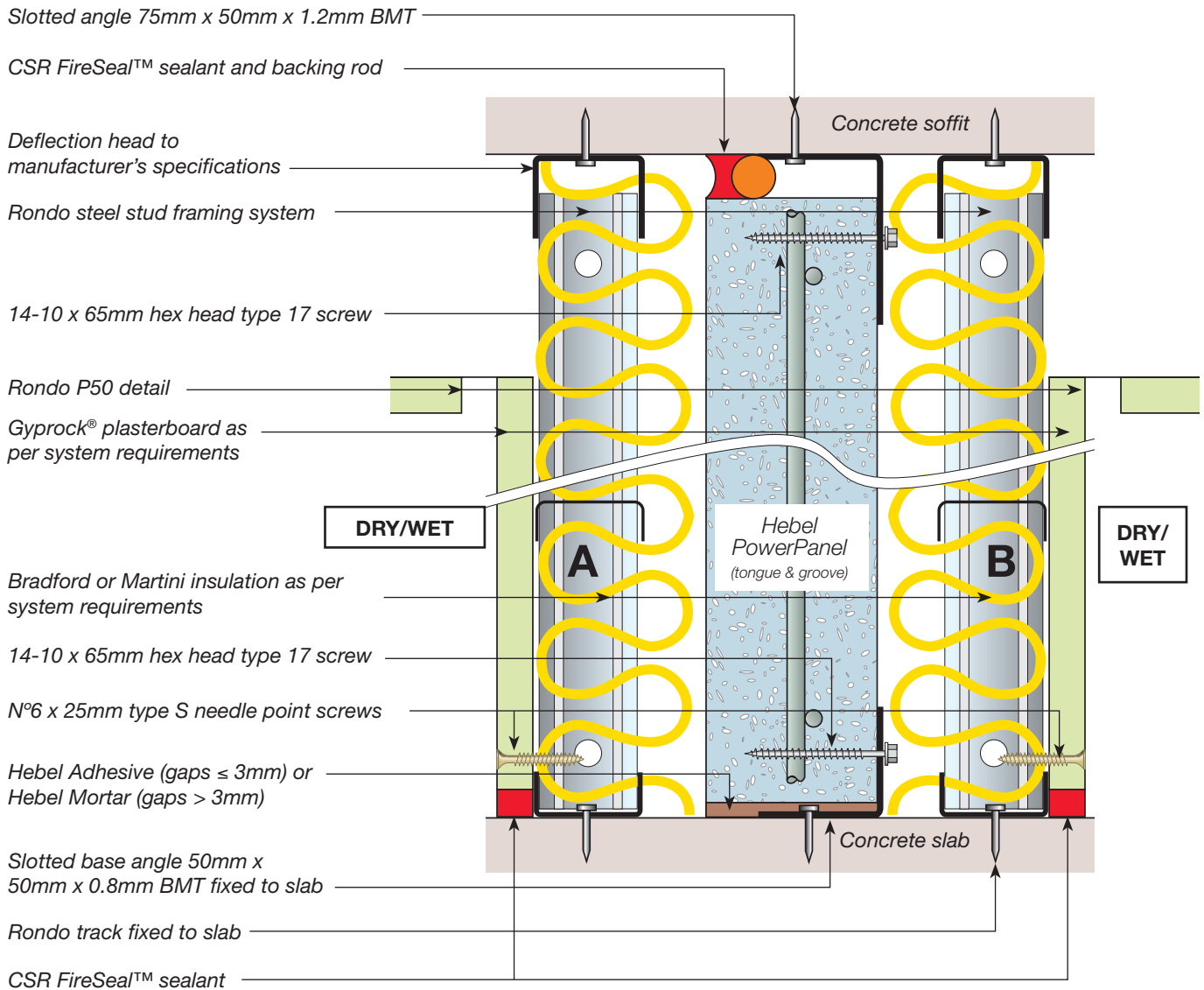

System	Application	FRL ^(A)	Wall linings ^(D)	Insulation A	Cavity width (mm)	Insulation B	Acoustic rating Rw+Ctr ^(C)	Wall width (mm)
HEB 1077	Dry to Dry	-/90/90 for wall heights up to 3.3m	Both Sides 13mm Gyprock CD	50mm Bradford Acoustigard	20	75mm Bradford Acoustigard	53	269
HEB 1078	Dry to Wet		Dry Side – 13mm Gyprock CD Wet Side – 13mm Aquacheck ^(B)	11 or 50mm Martini Prime		11 or 75mm Martini Prime	53	269
HEB 1079	Wet to Wet		Both Sides 13mm Aquacheck ^(B)				54	269

NOTES:

- (A) For wall heights higher than 3.3m, caged tongue & groove PowerPanel can be used and will achieve a FRL of -/120/120 for wall heights up to 4.65m (vertically). Also see Construction details section.
- (B) 13mm Aquacheck can be replaced by 9mm FC Sheeting and achieve the same Acoustic & Fire Rating Levels.
- (C) Rw+Ctr values are based on acoustic opinion 20140366.9/1606A/R8/GW provided by Acoustic Logic Consultancy Pty Ltd.
- (D) The minimum mass of plasterboard must be 8.5kg/m².

GENERAL NOTES:

- 1. Intertency wall systems HEB 1072-1073 meet NCC 2016 deemed-to-satisfy discontinuous construction requirements.
- 2. HEB 1077-1079 are designed to resist a maximum ultimate lateral pressure of 0.50kPa. Contact Hebel Technical Services if lateral pressures exceed 0.50kPa.



1.5 CORRIDOR WALL

concealed water services one side

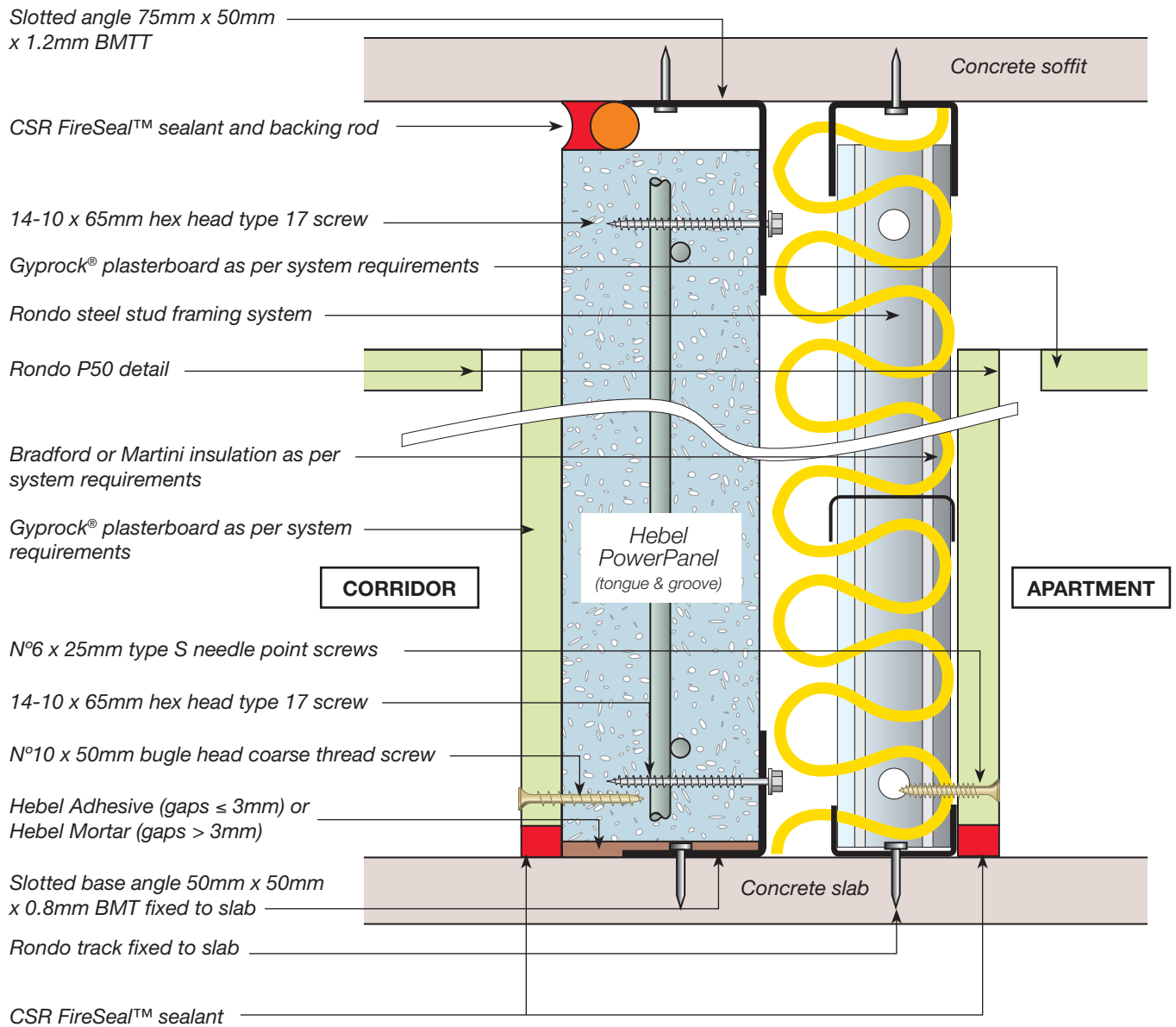

System	Application	FRL ^(A)	Wall linings ^(D)	Cavity width (mm)	Insulation	Acoustic rating R _w ^(C)	Wall width (mm)
HEB 1168	Dry to Dry	-/90/90 for wall heights up to 3.3m	Both Sides 13mm Gyprock CD	15	50mm Bradford Acoustigard 11 or 50mm Martini Prime	58	180
HEB 1169	Dry to Wet		Corridor Side – 13mm Gyprock CD Stud Side – 13mm Aquachek ^(B)			59	180

NOTES:

(A) For wall heights higher than 3.3m, caged tongue & groove PowerPanel can be used and will achieve a FRL of -/120/120 for wall heights up to 4.65m (vertically). Also see Construction details section.

(B) 13mm Aquachek can be replaced by 9mm FC Sheeting and achieve the same Acoustic & Fire Rating Levels.

(C) R_w values are based on acoustic opinion 20140366.9/1606A/R8/GW provided by Acoustic Logic Consultancy Pty Ltd.

(D) The minimum mass of plasterboard must be 8.5kg/m².

GENERAL NOTES:

1. HEB 1168-1169 are designed to resist a maximum ultimate lateral pressure of 0.50kPa. Contact Hebel Technical Services if lateral pressures exceed 0.50kPa.



1.6 CORRIDOR WALL

concealed water services one side with furring channel

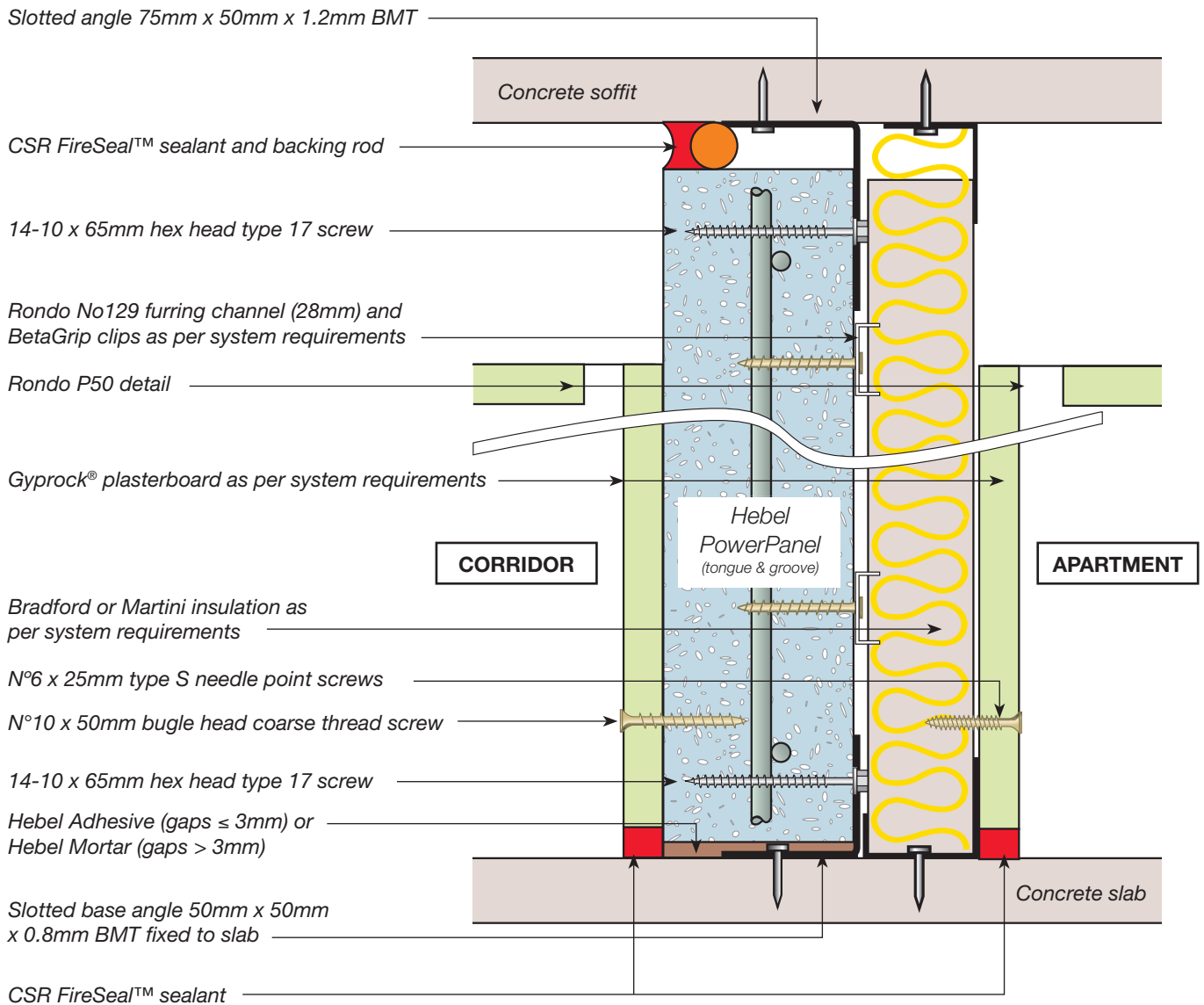

System	Application	FRL ^(A)	Wall linings ^(D)	Cavity width (mm)	Insulation	Acoustic rating $R_w^{(C)}$	Wall width (mm)
HEB 1170	Dry to Dry	-/90/90 for wall heights up to 3.3m	Both Sides 13mm Gyprock CD	43	50mm Bradford Acoustigard 11 or 50mm Martini Prime	52	144
HEB 1171	Dry to Wet		Corridor Side – 13mm Gyprock CD Stud Side – 13mm Aquacheck ^(B)			53	144

NOTES:

- (A) For wall heights higher than 3.3m, caged tongue & groove PowerPanel can be used and will achieve a FRL of -/120/120 for wall heights up to 4.65m (vertically). Also see Construction details section.
- (B) 13mm Aquacheck can be replaced by 9mm FC Sheeting and achieve the same Acoustic & Fire Rating Levels.
- (C) R_w values are based on acoustic opinion 20140366.9/1606A/R8/GW provided by Acoustic Logic Consultancy Pty Ltd.
- (D) The minimum mass of plasterboard must be 8.5kg/m².

GENERAL NOTES:

- 1. HEB 1170-1171 are designed to resist a maximum ultimate lateral pressure of 0.50kPa. Contact Hebel Technical Services if lateral pressures exceed 0.50kPa.



1.7 SHAFT WALL

adjacent to wet or common areas

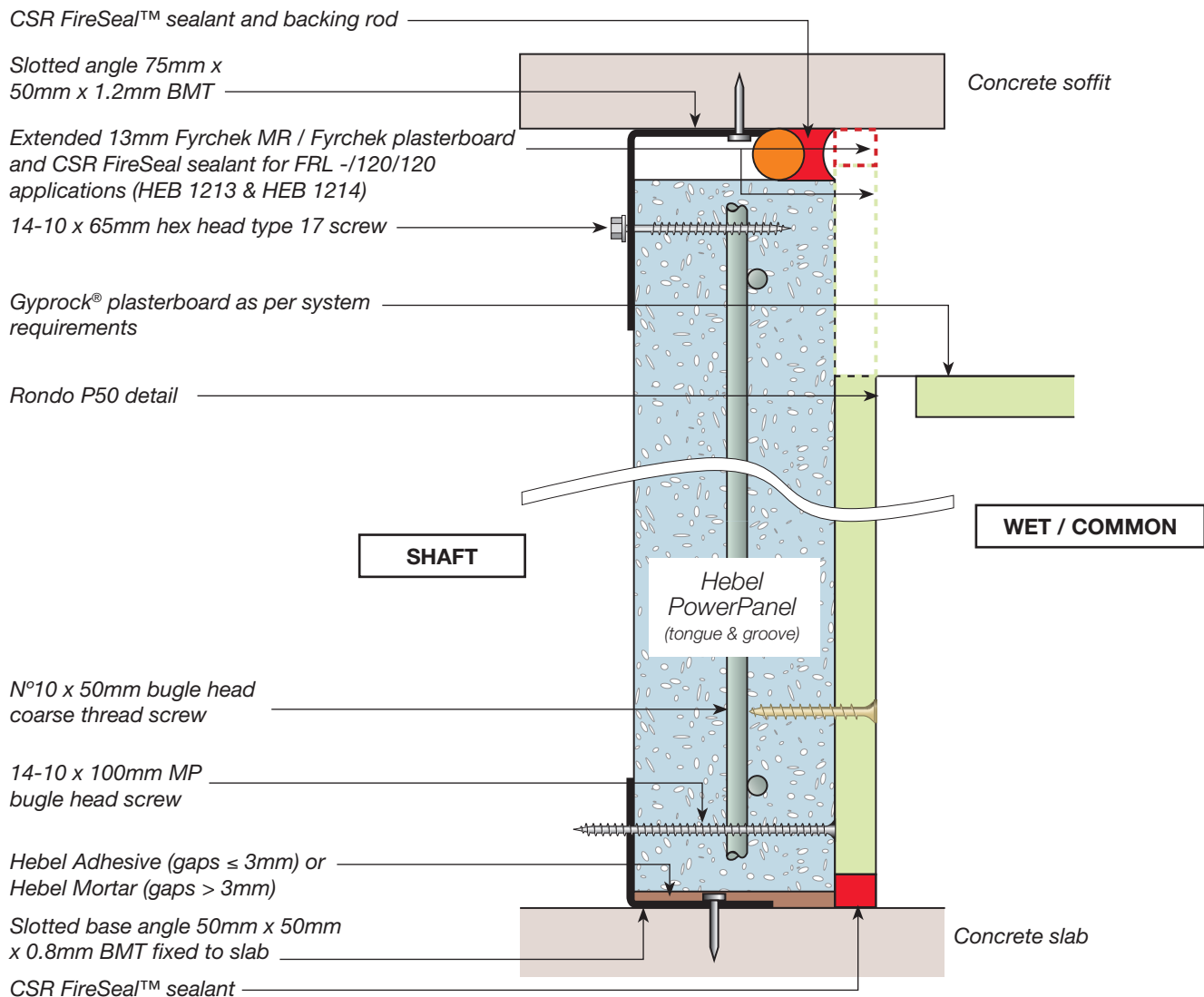

System	Application	FRL ^{(A),(B)}	Wall linings ^(E)	Acoustic rating Rw+Ctr ^(D)	Wall width (mm)
HEB 1211	Shaft to Wet	-/90/90 for wall heights up to 3.3m	13mm Aquachek ^(C)	34	88
HEB 1212	Shaft to Common		13mm Gyprock CD	33	88
HEB 1213	Shaft to Wet	-/120/120 for wall heights up to 3.3m	13mm Fyrchek MR	34	88
HEB 1214	Shaft to Common		13mm Fyrchek	34	88

NOTES:

(A) To achieve an FRL of -/120/120 for wall heights up to 3.3m use 13mm Fyrchek, or Fyrchek MR plasterboard direct fixed to the Hebel panels and extended to the concrete soffit as shown. CSR FireSeal sealant joints required to all perimeters of the plasterboard.

(B) For wall heights higher than 3.3m, caged tongue & groove PowerPanel can be used and will achieve a FRL of -/120/120 for wall heights up to 4.65m (vertically). Also see Construction details section.

(C) 13mm Aquachek can be replaced by 9mm FC Sheeting and achieve the same Acoustic & Fire Rating Levels.

(D) Rw+Ctr values are based on acoustic opinion 20140366.9/1606A/R8/GW provided by Acoustic Logic Consultancy Pty Ltd.

(E) The minimum mass of plasterboard must be 8.5kg/m².

GENERAL NOTES:

1. HEB 1211-1214 are designed to resist a maximum ultimate lateral pressure of 0.50kPa. Contact Hebel Technical Services if lateral pressures exceed 0.50kPa.



1.8 SHAFT WALL

adjacent to dry habitable rooms

CSR FireSeal™ sealant and backing rod

Slotted angle 75mm x 50mm x 1.2mm BMT

Optional: track or angle fixed to soffit

14-10 x 65mm hex head type 17 screw

Gyprock® plasterboard as per system requirements

Rondo No129 furring channel (28mm) and BetaGrip clips as per system requirements

Rondo P50 detail

SHAFT

DRY

Bradford or Martini insulation as per system requirements

Gyprock® plasterboard as per system requirements

N°6 x 25mm type S needle point screws

14-10 x 65mm hex head type 17 screw

Hebel Adhesive (gaps ≤ 3mm) or Hebel Mortar (gaps > 3mm)

Slotted base angle 50mm x 50mm x 0.8mm BMT fixed to slab

CSR FireSeal™ sealant

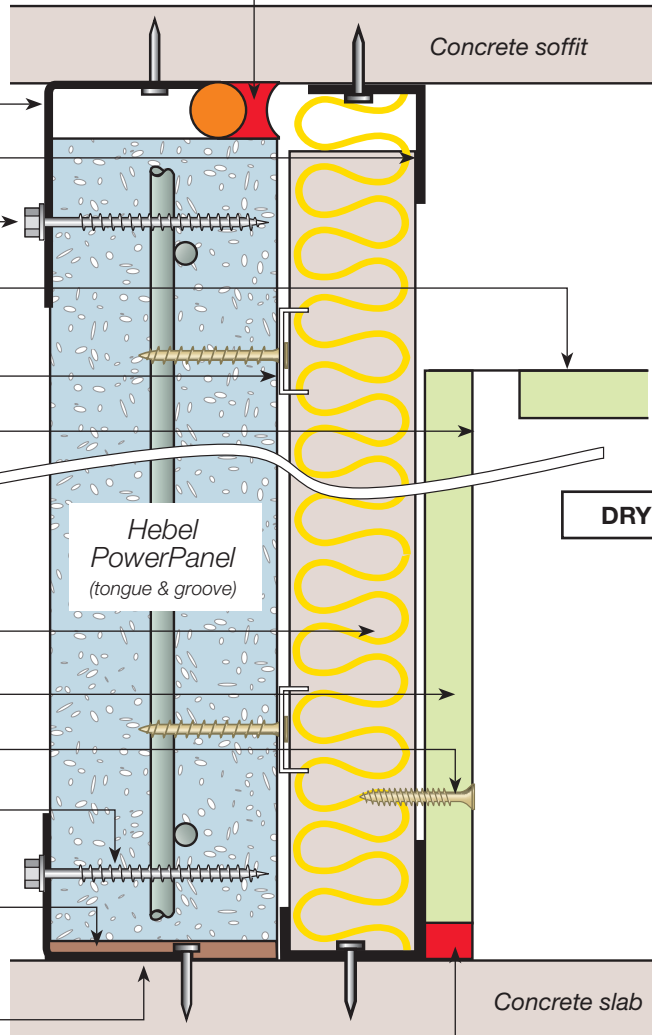

System	Application	FRL ^(A)	Wall linings ^(D)	Cavity width (mm)	Insulation	Acoustic rating Rw+Ctr ^(C)	Wall width (mm)
Hebel1160	Shaft to Dry	-/90/90 for wall heights up to 3.3m	13mm Gyprock CD	43	50mm Bradford Acoustigard 11 or 50mm Martini Prime	40	131
Hebel1162	Shaft to Wet		13mm Aquacheck ^(B)	28	NIL	37	116

NOTES:

(A) For wall heights higher than 3.3m, caged tongue & groove PowerPanel can be used and will achieve a FRL of -/120/120 for wall heights up to 4.65m (vertically). Also see Construction details section.

(B) 13mm Aquacheck can be replaced by 9mm FC Sheeting and achieve the same Acoustic & Fire Rating Levels.

(C) Rw+Ctr values are based on acoustic opinion 20140366.9/1606A/R8/GW provided by Acoustic Logic Consultancy Pty Ltd.

(D) The minimum mass of plasterboard must be 8.5kg/m².

(E) 50mm Martini should not be used where non-combustible building elements are required

GENERAL NOTES:

1. HEB 1208 & 1210 are designed to resist a maximum ultimate lateral pressure of 0.50kPa. Contact Hebel Technical Services if lateral pressures exceed 0.50kPa.



1.9 SERVICES WALL

for walls up 3.3 metres high

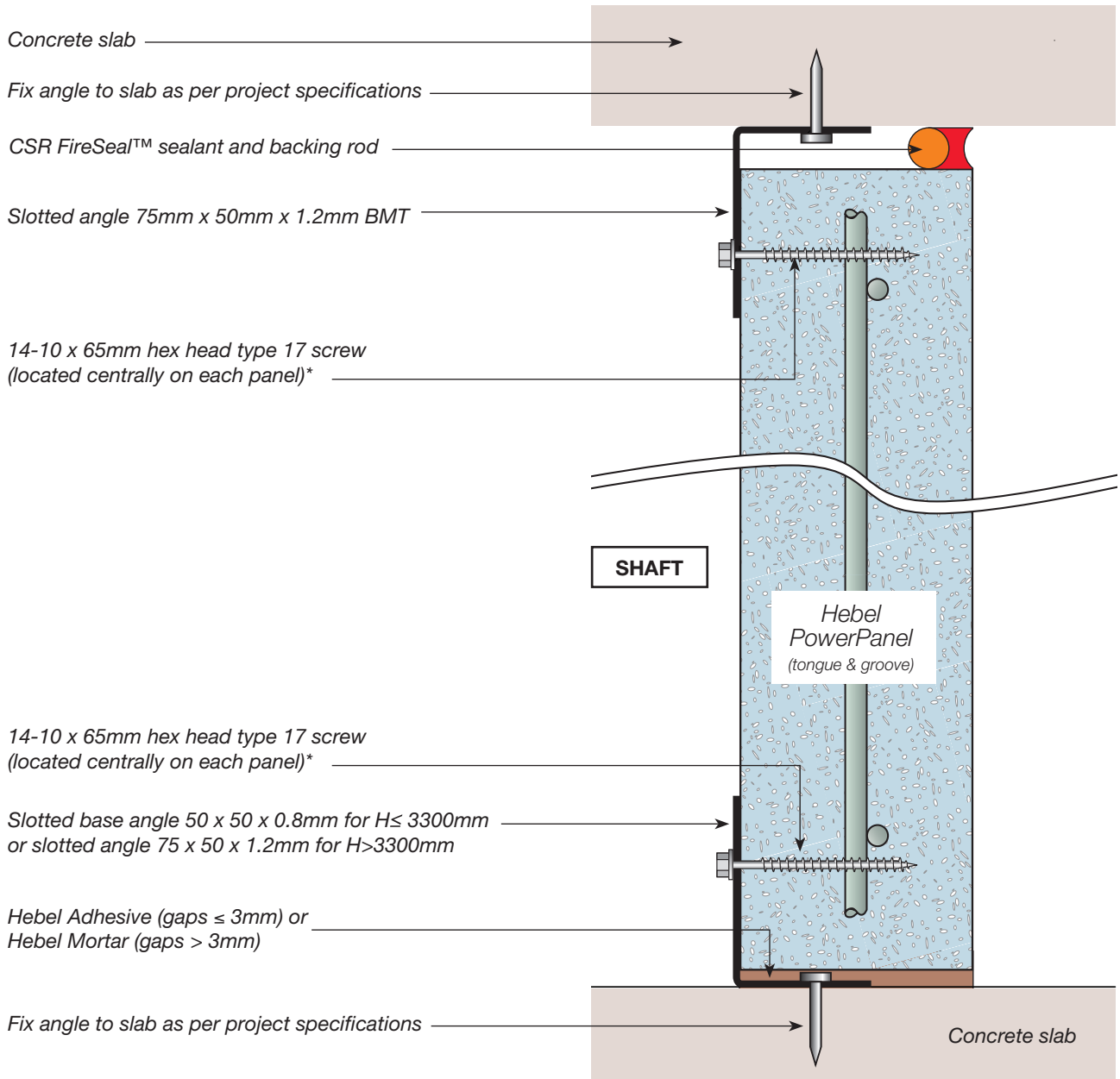

Code	Application	FRL ^(A)	Wall linings	Hebel component	Acoustic rating Rw ^(B)	Wall width (mm)	Paint finish
HEB 1400	Bare Shaft	-/90/90 for wall heights up to 3.3m	Nil	75mm PowerPanel T&G	33	75	Optional

NOTES:

(A) Also see Construction details section.

(B) Rw values are based on acoustic test ATF-676.

GENERAL NOTES:

1. HEB 1400 is designed to resist a maximum ultimate lateral pressure of 0.50kPa. Contact Hebel Technical Services if lateral pressures exceed 0.50kPa.



1.10 SERVICES WALL

for walls with 2 hour fire rating up to 4.65 metres high

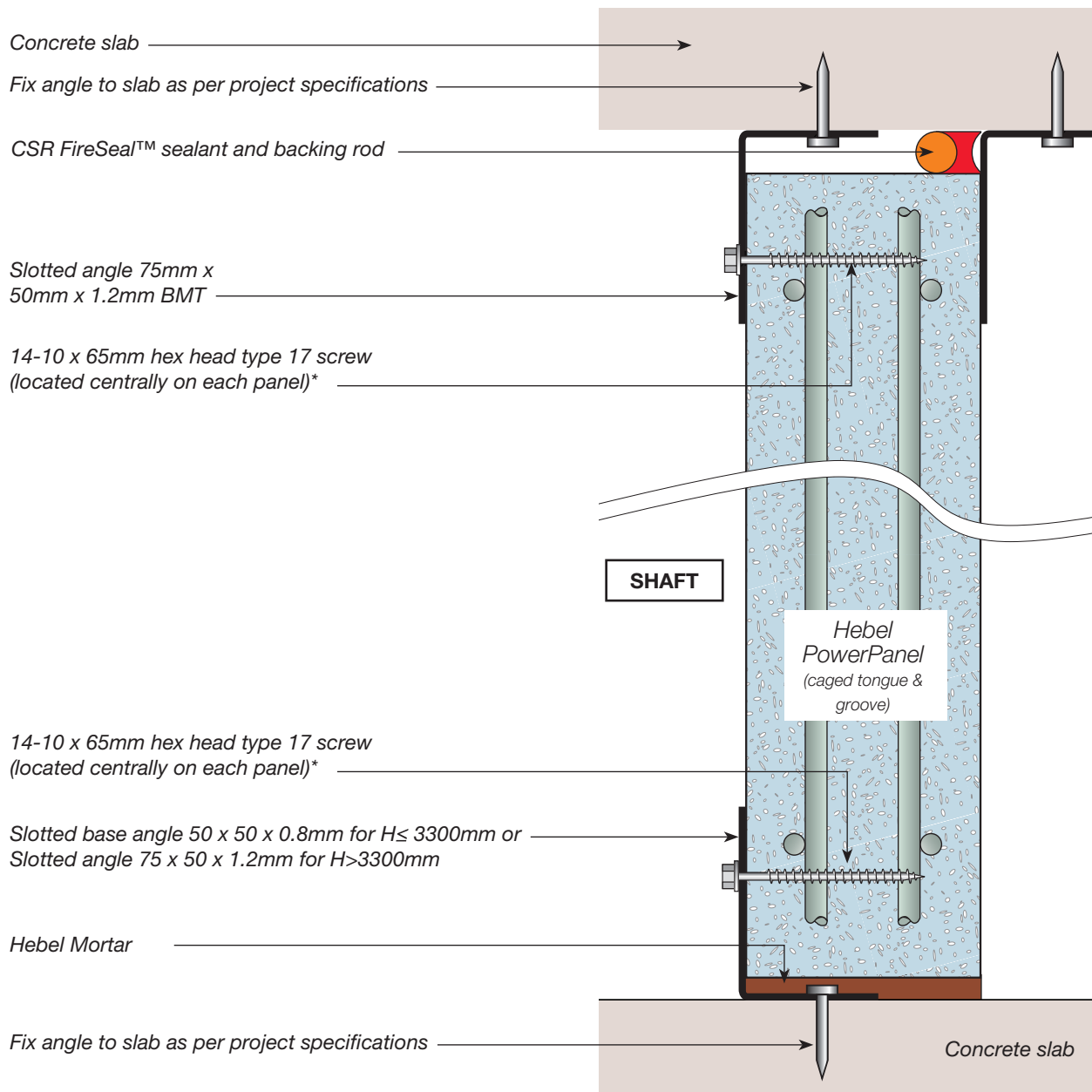

Code	Application	FRL ^(A)	Wall linings	Hebel component	Acoustic rating Rw ^(B)	Wall width (mm)	Paint finish
HEB 1207	Bare Shaft	-/120/120 for wall heights up to 4.65m	Nil	75mm caged T&G PowerPanel	33	75	Optional

NOTES:

(A) Also see Construction details section.

(B) Rw values are based on acoustic opinion 2010861.3/1506A/R0/GW provided by Acoustic Logic Consultancy Pty Ltd.

GENERAL NOTES:

1. HEB 1207 is designed to resist a maximum ultimate lateral pressure of 0.50kPa. Contact Hebel Technical Services if lateral pressures exceed 0.50kPa.

1.11 SYSTEM COMPONENTS

HEBEL POWERPANEL

The primary component of Hebel internal wall systems is the 75mm Hebel PowerPanel which is manufactured in a range of standard and made-to-length sizes as indicated in Table 1.11.1. The standard panel is produced as a stock item. Made-to-length is subject to production lead times.

Table 1.11.1 Hebel PowerPanel tongue & groove 75mm standard and made-to-length sizes

	Profile	Reinforcement	Fire rating level	Length mm	Width mm	Ult. wind load kPa	Weight kg/m ²
Standard sizes (stock)	Tongue & groove	Single mesh	-/90/90	2700	600	0.50	49
				2800	600	0.50	49
				2850	600	0.50	49
				2900	600	0.50	49
				3000	600	0.50	49
				3300	600	0.50	49
		Caged mesh	-/120/120	3600	600	0.50	53
				4200	600	0.50	53
Made-to-length sizes (5mm increments)	Tongue & groove	Single mesh	-/90/90	up to 3300	600	0.50	49
		Caged mesh	-/120/120	up to 4800	300-600	0.50	53

Notes: Average panel weight calculated 30% moisture content ^Panels over 3300mm use caged mesh.

Hebel recommends that the following components or equivalent be used:

Table 1.11.2 Typical Hebel intertenancy and corridor wall components

Wall components	Intertenancy walls Max. floor space, concealed services one side only	Intertenancy walls Max. floor space, concealed services both sides	Intertenancy walls Large concealed services both sides	Corridor walls Max. floor space, concealed services one side only	Corridor walls Max. floor space, concealed services one side, with furring channel
Hebel PowerPanel tongue & groove single or caged mesh	✓	✓	✓	✓	✓
Head and vertical / slotted angle (75mm x 50mm x 1.2mm BMT)	✓	✓	✓	✓	✓
Base / slotted base angle (50mm x 50mm x 0.8mm BMT)	✓	✓	✓	✓	✓
Furring channel		✓			✓
Steel stud framing	✓	✓	✓	✓	
Furring channel mounting clips		✓			✓
Gyprock® plasterboard	✓	✓	✓	✓	✓
Hebel Adhesive or Hebel Mortar	✓	✓	✓	✓	✓
Bradford or Martini insulation	✓	✓	✓	✓	✓
Fasteners / fixings	✓	✓	✓	✓	✓
CSR FireSeal™ fire and acoustic sealant	✓	✓	✓	✓	✓
Hebel Patch	✓	✓	✓	✓	✓
Hebel Anti-Corrosion Protection Paint	✓	✓	✓	✓	✓

Table 1.2.3 Typical Hebel shaft and service wall components

Wall components	Shaft walls General partitions on service shaft to wet areas or shafts adjacent to common areas	Shaft walls Max. floor space with concealed services one side	Services wall Separating walls to isolate and secure plants from other areas. FRL -/90/90 up to 3.3m	Services wall Separating walls to isolate and secure plants from other areas. FRL -/120/120 up to 4.65m	Horizontal Shaft wall
Hebel PowerPanel tongue & groove single or caged mesh	✓	✓	✓	✓	✓
Head and vertical/ slotted angle (75mm x 50mm x 1.2mm BMT)	✓	✓	✓	✓	✓
Base / slotted base angle (50 x 50 x 0.8mm for H≤3300mm) (75 x 50 x 1.2mm for H>3300mm)	✓	✓	✓	75 x 50 x 1.2mm only	75 x 50 x 1.2mm only
Furring channel		✓		Optional	Optional
Furring channel mounting clips		✓		Optional	Optional
Gyprock® plasterboard	✓	✓		Optional	Optional
Hebel Adhesive	✓	✓	✓	✓	✓
Hebel Mortar			✓	✓	✓
Hebel Patch	✓	✓	✓	✓	✓
Bradford or Martini insulation		✓			
Fasteners / fixings	✓	✓	✓	✓	✓
CSR FireSeal™ fire and acoustic sealant	✓	✓	✓	✓	✓
Hebel Anti-Corrosion Protection Paint	✓	✓	✓	✓	✓

Note: CSR has engineered and tested the PowerPanel system to comply with the National Construction Code (NCC) and relevant Australian Standards. It cannot guarantee products and accessories not specified and sold by CSR will perform to these standards. The Product Guarantee will only apply if all components used in the system are specified and sold by CSR or its agents

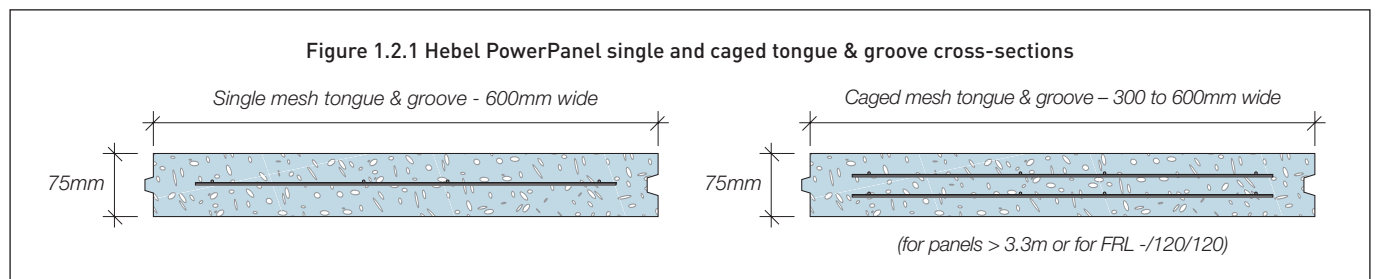

SLOTTED ANGLE CONNECTIONS

For positioning and restraining (with added screw fixings) the top and bottom of the panels. See Table 1.2.2 for typical intertenancy and corridor walls. See Table 1.2.3 for typical shaft and services walls.

- Slotted galvanised steel angle for head, vertical and base connections for H > 3300mm and/ or for 2 hour rated systems. 75 x 50 x 1.2mm BMT. Minimum slot height 20mm.
- Slotted galvanised steel angle for base connection for H ≤ 3300mm. 50 x 50 x 0.8mm BMT

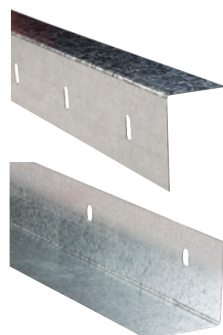

All angles with BMT greater than 0.8mm will have to be slotted to allow penetration of fixings. Head connections require slotted angle to allow for deflection of slab above.

HEBEL ADHESIVE

Hebel Adhesive (supplied in 20kg bag) is used for bonding the panels together at vertical and horizontal joints or for gaps at base ≤ 3mm.



HEBEL MORTAR

Hebel Mortar (supplied in 20kg bag) is used to provide a level base for panel installation as well as providing acoustic and fire protection at the base of the panels.

HEBEL PATCH

Minor chips or damage to panels are repaired using Hebel Patch (supplied in 10kg bag).

CSR FIRESEAL

To attain the specified FRL and/or R_w requirements, all perimeter gaps and penetrations must be carefully tooled and completely filled with CSR FireSeal installed to the manufacturer's specifications.

BACKING ROD

CSR Hebel recommends the use of an open cell polyurethane backing rod which ensures the correct depth of sealant is achieved. The backing rod provides a firm backing against which sealant can be tooled, and allows the sealant to bond on both sides of the joint to the Hebel substrate. The open cell backing facilitates faster curing time and is much more compressible, allowing use in a wider range of joints.

HEBEL ANTI-CORROSION PROTECTION PAINT

Reinforcement exposed when panels are cut must be coated with a liberal application of Hebel Anti-Corrosion Protection Paint.



FURRING CHANNEL MOUNTING CLIPS

Clips are proprietary components enabling the mounting of furring channel and plasterboard onto Hebel PowerPanel. This provides a cavity space which can change the acoustic insulation performance of the wall system. Clips used on Hebel intertenancy and corridor walls are:

- BetaGrip1 (BG01) clip

STEEL STUD FRAMEWORK

Zinc coated steel studs, noggings, head and base tracks are used to create separated stud framework, which in conjunction with the Hebel PowerPanel, provides an asymmetric cavity wall assembly.



There are a number of different steel stud framework component manufacturers. All steel stud framework components are to be designed in accordance with manufacturer's specifications, and AS/NZS 4600.

FURRING CHANNEL

Rondo galvanised steel furring channels are mounted onto the BetaGrip clips. Furring channel used:

- Rondo N°129, 28 x 38 x 0.50mm, BMT channels



BRADFORD GLASSWOOL

Manufactured in Australia Bradford Glasswool boards and blankets provide excellent fire resistance and acoustic performance properties for intertenancy, corridor and shaft walls. Bradford Glasswool products are manufactured by spinning molten glass, containing up to 65% recycled content, into fine wool like fibres. These are bonded together using a thermosetting resin and employ safe to handle FBS-1 biosoluble Glasswool formulation. Products meet AS/NZS4859 requirements to ensure performance for the life of the building.

BRADFORD FIRESEAL™

The Bradford Fireseal range provides rockwool fire protection insulation products designed to meet the NCC fire requirements for intertenancy walls and is typically used in junctions of intertenancy and external brick walls. This range is made from biosoluble rockwool, an insulation material specially formulated to provide fire protection. It is manufactured by spinning a molten mixture of natural rock and recycled blast furnace waste products into fibres which are bonded with a thermosetting resin.

MARTINI POLYESTER INSULATION

CSR Martini insulation is manufactured from 100% polyester fibre, containing up to 80% recycled fibre content made from post-consumer waste materials such as PET packaging and empty drink bottles. Thermally bonded and containing no resin binders, Martini insulation is non-irritant and has no requirement for special PPE during installation.

CSR Martini has undertaken rigorous research, development and testing, resulting in products with specifically engineered fibre blends and densities that deliver on acoustic and thermal performance and comply with all relevant Australian standards.

For high rise apartment projects, we recommend the use of Martini Prime™ at specified thicknesses for all wall and ceiling cavities. Used in conjunction with CSR Hebel and CSR Gyprock systems, Martini Prime™ will assist in achieving the acoustic and thermal standards required for high rise internal walls and ceilings to comply with the National Construction Code (NCC) provisions.

Additional information is available from CSR Martini.

GYPROCK® PLASTERBOARD

Hebel intertenancy and corridor walls incorporate Gyprock® plasterboard on both sides. The type, thickness and densities of plasterboard will be as per the specified wall requirements. The minimum mass of plasterboard must be 8.5kg/m².

Additional information is available from CSR Gyprock.

FIXINGS

Most screw fixings are timber type, which is sufficient for penetrating the metal thicknesses outlined in this Design Guide. Connections that have larger metal thicknesses may require a metal type screw and will need to be designed and approved by the project engineer.

Slotted head / base angles to concrete fixings

The fixing to secure the tracks to the concrete slab and soffits shall be capable of withstanding a shear load of 0.75kN per metre (for wall heights up to 3.0 metres). For high wind pressures the designer shall determine if mechanical fasteners are required. The following minimum fixings shall be provided:

- Drive pins and concrete nails (check size and suitability for fire rated situations with the manufacturer).
- 6mm diameter mechanical fasteners.

PowerPanel to slotted head and base angle fixings

- Use 14-10 x 65mm hex head type 17 screw or equivalent, when fixing through the angle into the panel. Angles with BMT greater than 0.8mm will have to be slotted.



- Use 14-10 x 150mm hex head type 17 screw or equivalent, when fixing into panel at corner or T-junction.



- Use 14-10 x 100mm MP bugle head screw or equivalent, when fixing through panel and into angle. For angles with BMT greater than 0.8mm, screw will require the appropriate tip.



Gyprock® plasterboard to PowerPanel fixing

- N°10 x 50mm bugle head coarse thread screw or equivalent.



Furring channel mounting clip to PowerPanel fixing

- 12-11 x 65mm hex head screw type 17.



Gyprock® plasterboard to furring channel / metal stud fixing

- N°6 x 25mm type S needlepoint screw or equivalent.

Door frames to PowerPanel fixings

- N°8 x 50mm coarse thread screw or equivalent. Check screw requirements with door manufacturer's specifications.

2.1 ACOUSTIC PERFORMANCE

NCC COMPLIANT HEBEL INTERNAL WALL SYSTEMS

The wall systems outlined have been assessed to comply with the NCC requirement for intertenancy, corridor, shaft and service walls. This table must be read in conjunction with all information provided in this Design and Installation Guide, and acoustic opinions 20140366.9/1606A/R8/GW and 2010861.3/1506A/R0/GW provided by Acoustic Logic Consultancy Pty Ltd and acoustic test ATF-676. Selection of Hebel internal wall systems shown in the table should be taken with specialist consultant's advice. For walls requiring discontinuous construction, the gap/cavity must be 20mm minimum.

IMPACT SOUND PERFORMANCE

All Hebel intertenancy and corridor walls are cavity wall systems without connections between the separate wall leaves. Therefore, no mechanical path exists for the transmission of impact sound. Provided a 20mm gap is maintained between the separated wall leaves, all intertenancy and corridor walls can meet the 'discontinuous construction' requirement of the NCC.

ACOUSTIC PERFORMANCE DESIGN RECOMMENDATIONS

1. Hebel recommends engaging a specialist acoustic consultant on a project-by-project basis to provide design advice, confirmation of anticipated field performance, detailing and installation inspections.
2. When selecting the appropriate Hebel wall, the designer or specifier must be aware that the laboratory R_w values are almost always higher than the field measured values. Therefore, allowances should be made for the lower expected field values during the selection of the system.
3. Separate advice from a specialist acoustic consultant should be sought to determine the effect on acoustic performance due to any changes to the Hebel wall systems, and any required modification of the installation details pertaining to the systems.
4. Increasing of cavity widths, using higher density or thicker insulation or plasterboard, will generally maintain or increase the acoustic performance of the Hebel wall.
5. The acoustic performance values of the Hebel walls shown in the systems pages are a guide only as to

expected lab test performance. They do not constitute a field performance guarantee as factors such as the presence of flanking paths, quality of installation of the system, onsite detailing of junctions, room shapes and size, etc can significantly affect field performance. Maximising the field performance depends on the following factors:

- systems are installed in accordance with the manufacturer's standard installation details.
- good quality installation practices including the sealing of all junctions and joints and maintaining specified clearances.
- systems are installed with all junctions acoustically sealed so that negligible sound transmission occurs at these points.
- all services penetrations, etc are acoustically sealed and treated so that negligible sound transmission occurs through these points.
- flanking paths are eliminated and the structures into which the systems are installed are capable of allowing the nominated rating to be achieved
- site testing conditions.

2.2 FIRE RATING PERFORMANCE

FIRE RESISTANCE LEVEL (FRL) RATINGS

The maximum wall heights in the systems described in this Design and Installation Guide are taken from CSIRO Fire Test Report FSV-0979 and Exova Warringtonfire Assessment Report 26095-13. These values are only applicable to the Hebel walls outlined in this Design and Installation Guide.

The fire performance for the various junctions of these wall systems (head details at concrete soffit, wall base details, control joint details including junctions with concrete walls and columns and a suite of service penetrations details) using CSR FireSeal sealant are covered in Exova Warringtonfire Assessment Report 27915-13.

The FRL rating of the wall can be affected by the penetrations and the method adopted to protect these penetrations. A fire collar with a -/60/60 FRL rating will govern the FRL of the wall, even if the wall configuration has a FRL rating of -/90/90.

FIRE PROTECTION OF PENETRATIONS

Penetrations through a Hebel wall to accommodate pipework, electrical cabling or ductwork will have to be protected (fire stop), to prevent the spread of fire through the penetration.

CSR Hebel provides a fire-rated sealant, CSR FireSeal and recommends contacting a reputable manufacturer of fire protection systems for other appropriate products such as fire collars.

2.3 STRUCTURAL PERFORMANCE

STRUCTURAL PERFORMANCE

Hebel internal wall systems are non-loadbearing walls used in internal applications. The walls are designed to resist a maximum ultimate lateral pressure of 0.50kPa, and a deflection limit of H/240 (Height ÷ 240) or 20mm maximum.

Table 2.3.1 Recommended minimum gap between the stud frame and PowerPanel

Wall height (mm)	H/240 (mm)	Minimum gap (mm)
2400	10	12
2550	11	13
2700	12	14
2850	12	14
3000	13	15
3200	14	16
3550	15	17
3900	17	19
4200	18	20

CUTTING OF HEBEL POWERPANEL

For the load parameters outlined above (UDL ≤ 0.50kPa/ultimate), the standard Hebel PowerPanels can be reduced in length by cutting 150mm maximum from each end, and to a minimum width of 270mm. For UDL loads greater than 0.50kPa (ultimate), custom Hebel PowerPanel will have to be designed to ensure structural adequacy when cut.

STEEL STUD FRAME

The steel framing presented in this Design and Installation Guide for various wall systems has not been approved for the design parameters in this Design and Installation Guide. It is the designer’s responsibility to determine an appropriate steel framing system. Several items the designer must allow for are: lateral loadings, wall height, deflection limits, offset distance (gap) from the panel, building movement and control joint locations.

As a minimum the wall will have a deflection limit of H/240. As a guide, Hebel recommends providing a minimum gap distance of Height/240 + installation tolerance. For example, H = 2400mm and installation tolerance = 2mm, then minimum gap = 2400/240+2 = 12mm. This is to ensure that the two leaves of the cavity wall do not touch during service loading. Table 2.3.1 outlines the recommended minimum gap to suit a range of wall heights for the H/240 deflection limit. For walls requiring discontinuous construction a minimum gap of 20mm must be specified to meet the NCC requirements.

CUSTOM HEBEL POWERPANEL

For walls heights exceeding 3300mm or design parameters outside the scope of this guide, the panels will be custom Hebel PowerPanels. These panels are designed to satisfy the project’s individual design parameters, such as internal lateral (wind) pressure and onsite cutting requirements. Custom panels are subject to manufacturing lead times.

EARTHQUAKE LOADING

Earthquake loading has not been considered in this Design and Installation Guide.

3.1 INSTALLATION FLOWCHARTS

HEBEL WALL LEAF SHOULD BE INSTALLED BEFORE SERVICES

Figure 3.1.1 Intertency, corridor and shaft wall systems with linings - Vertical installation

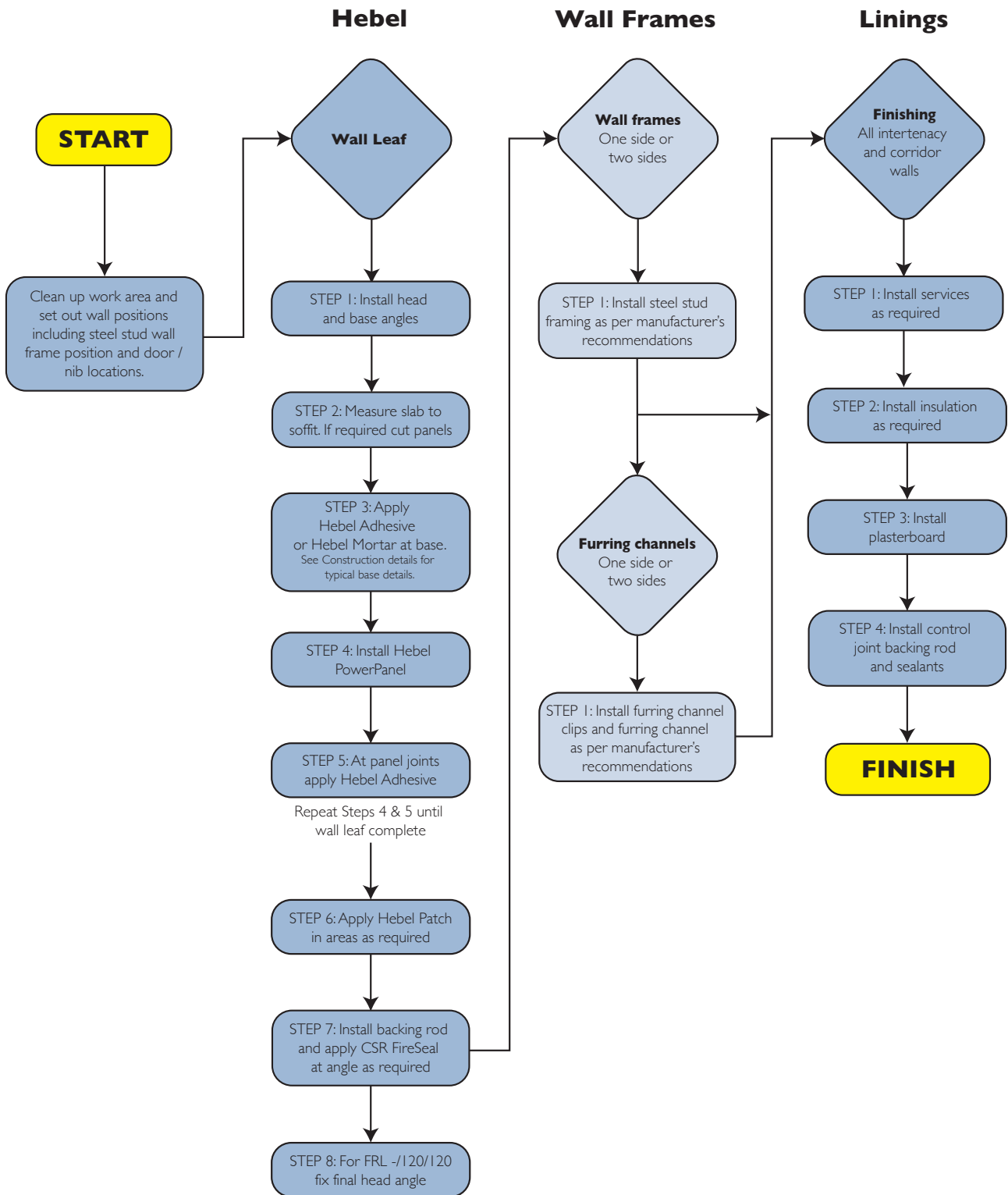
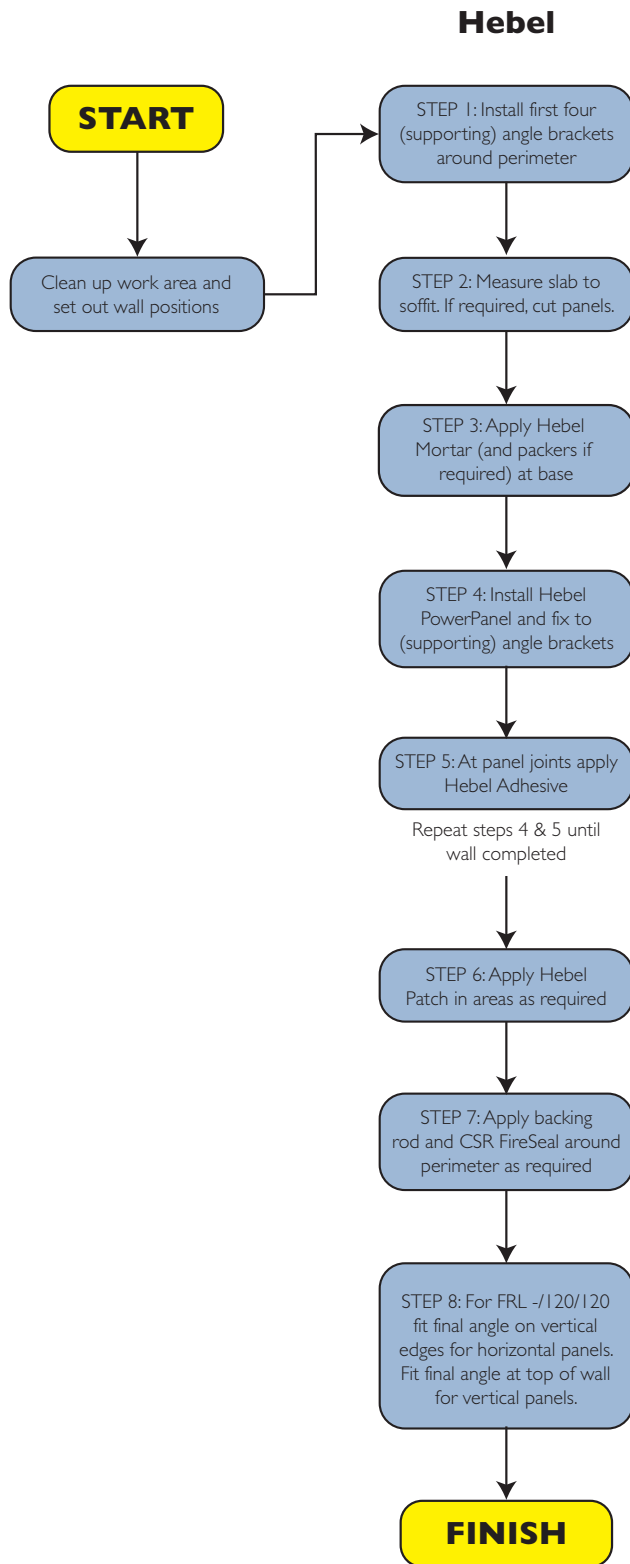

Figure 3.1.2 Shaft and services wall systems - vertical and horizontal installation



3.2 INSTALLATION

HEBEL WALL LEAF SHOULD BE INSTALLED BEFORE SERVICES

SETTING OUT AND POSITIONING OF WALLS

Before commencing any installation work, clean and tidy up the work area. Mark out the location of the walls and door nibs, etc.

SLOTTED HEAD AND BASE ANGLE INSTALLATION

When the wall locations have been set out, fix the slotted angles and base angles to the concrete support structures. This is done using suitable fixings (see **System components** section) at 600mm maximum centres and maximum 100mm from ends. Seal all butt joints in head angle with CSR FireSeal.

HEBEL POWERPANEL INSTALLATION

The panels can be cut onsite using a circular saw equipped with diamond tipped turbo cutting blade (for panel cutting limitations (see **Structural performance** section). All the loose AAC particles should be brushed off the panel with a stiff broom. Steel reinforcement that is exposed during cutting must be coated with a liberal application of Anti-Corrosion Protection Paint (see **System components** section). Any minor damage and chips to the panels must be repaired using Hebel Mortar.

Apply Hebel Adhesive or Hebel Mortar to base before installing panel. For gaps up to 3mm use Hebel Adhesive. For gaps over 3mm pack up with Hebel Mortar (maximum 15mm).

Fix the panel to the head and base angle with a minimum of two screws (see **System components** section), 50mm minimum from each end of the panel.

For following panels, apply thin bed adhesive to the entire vertical edge and install the next panel. Repeat the installation process until the wall is complete.

HEBEL ADHESIVE APPLICATION

Hebel Adhesive is applied to the panel with a trowel.

When the panels are pushed together the joints are to be 2-3mm thick. Sufficient pressure must be applied to the panels when gluing to ensure the adhesive is fully bedded across the joint. Scrape off any excess adhesive protruding from the joints and fill any gaps.

Adhesive is to be mixed to the proportions and consistency as per the instructions on the bag.

BACKING ROD AND CSR FIRESEAL APPLICATION

The backing rod should be installed to the manufacturer's specifications.

CSR FireSeal should be applied with a minimum 10mm depth in all applications. Maximum widths are shown in the **Construction details** section of this Design and Installation Guide. For details not shown please contact CSR Hebel.

FURRING CHANNEL CLIP INSTALLATION

The installation of the clips is typically at a maximum 600mm horizontal spacing and 1200mm vertical spacings. See **System components** section for appropriate fixings.

FURRING CHANNEL INSTALLATION

Furring channels are fitted in floor / soffit tracks and clips on the wall. Furring channels should also be installed so they extend to the floor. For further information refer to manufacturer's literature.

STEEL STUD FRAMEWORK INSTALLATION

All steel stud frameworks are to be installed to the manufacturer's specifications.

INSTALLATION OF BRADFORD OR MARTINI INSULATION

Installation of insulation should be completed in accordance with manufacturer's handling and installation guidelines. The thickness of insulation provided should fully fill the cavity between studs or furring channels.

Insulation must be installed from concrete slab to concrete soffit. If there is any gap in the insulation the acoustic performance of the system may be adversely affected.

GYPROCK® PLASTERBOARD

Plasterboard sheets must be cut to fit neatly and should not be forced into position. The plasterboard is to extend to at least the ceiling level.

In Hebel intertenancy and corridor walls plasterboard is fixed directly to Hebel PowerPanel, steel furring channel or stud framework:

- Direct fix to Hebel: plasterboard is to be installed in accordance with the Gyprock® plasterboard installation guidelines. Appropriate screws must be used to secure in position (see **System components** section).
- Fit to furring channel or stud frame: plasterboard is to be installed in accordance with the Gyprock® Steel FrameWall Systems Installation Guide, N°GYP544.

The minimum mass of plasterboard must be 8.5kg/m².

Handling and installation guidelines and additional information is available through CSR Gyprock.

Note: plasterboard must be screw-fixed only as gluing of sheets can adversely affect acoustic rating of system.

INSTALLATION OF FINAL SEALANTS

All movement joints and other gaps should be sealed off and finished neatly with CSR FireSeal. Installation of CSR FireSeal must be carried out in accordance with the manufacturer's specifications.

INSTALLATION OF PENETRATIONS: ELECTRICAL, PLUMBING AND OTHER SERVICES

Installation of services and penetrations into Hebel internal wall systems should be carried out in an appropriate construction sequence. This will allow easy access to cavities, steel framed elements and Hebel panels, where services can be easily installed and neatly hidden. Hebel recommends installing the plumbing and cabling after the panels have been installed. The builder or project manager should confirm appropriate construction sequence for services and penetrations on a project by project basis.

Neat finishes for all penetrations are necessary to maintain the acoustic and fire integrity of the wall. See **Construction details** section in this Design and Installation Guide.

Hebel internal wall systems can accommodate penetrations without a reduction in structural performance where no more than one third the panel width is cut out of any one panel (maximum 200mm for a 600mm wide Hebel PowerPanel). The edge of the penetration should be a 15mm maximum from the service passing through the wall.

Contact your fire and acoustic consultants for detailing of penetrations to ensure the nominated fire and/or acoustic performance is achieved.

INSTALLATION OF FASTENERS AND FIXINGS

All fixings and fasteners should be installed in accordance with the manufacturer's specifications.

The correct sized fasteners for the construction of the wall system must always be used. Refer to the **System components** section for these fasteners. When fitting large or heavy fixtures, guidance on the correct fasteners can be found in the Hebel Technical Manual and / or fastener manufacturer's recommendations.

3.3 DESIGN & INSTALLATION CONSIDERATIONS

ACOUSTIC AND FIRE INTEGRITY

Penetrations in walls for electrical fittings, telecommunications, large ductwork or plumbing systems can be a substantial source of sound leakage, which can affect the acoustic and fire performance of the wall.

When electrical, telecommunication or plumbing services are required, the contractor should install these services neatly and, when passing through the wall, should provide a close fitting hole, sealed with CSR FireSeal. Details of fire stopping products not covered within this Design & Installation Guide are to be specified by an appropriate consultant and installed in accordance with the manufacturer’s recommendations.

To prevent noise from water pipes degrading the acoustic amenity of the wall system, these pipes should be acoustically wrapped and resiliently fastened.

Where acoustic integrity is important, electrical switches must not be installed back-to-back as this could be a source of sound leakage. Refer Figure 3.3.1 (below) for switch box layout guidance.

Note: wall chasing is not permitted in accordance with the NCC (Volume 1 Specification F5.2).

CONTROL JOINTS

Control joints must be provided at a maximum of 6m spacing. Recommended control joint widths should be 10mm minimum between PowerPanel and other building component. Control joints must also be provided to coincide with any control joint in the main structure. The slotted head angle and base angle must be discontinuous at a structural control joint. Refer to the **Construction details** section for control joint details.

DOOR FRAMES

Door frames can either be built-in as the wall is being constructed or fitted after the Hebel PowerPanel has been installed. Samples of door frame details have been included in the **Construction details** section. For further information and installation requirements, please contact your chosen door frame manufacturer.

FIRE DAMPERS

Hebel internal wall systems can accommodate penetrations for fire dampers installed between two Hebel PowerPanels where no more than one third of the panel width is cut out of any one panel. The gap between the fire damper and the wall is to be treated in accordance with fire damper manufacturer’s recommendations. Refer to the **Construction details** section for a typical fire damper detail.

WALL CHASING

Wall chasing is not permitted in accordance with the NCC (Volume 1 Specification F5.2) in any acoustic or fire rated wall system.

WET AREA WALL CONSTRUCTION

Wet area wall construction may require a system that enables services to be installed in a cavity. Where back-to-back services are to be installed, a system that incorporates a cavity on both sides of the wall is required. All plumbing should be acoustically treated as required by the NCC. All wet area walls should be lined and waterproofed in accordance with Australian standards and to NCC requirements. Gyprock Aquachek™ or Cemintel™ Wallboard are suitable lining materials for wet area applications.

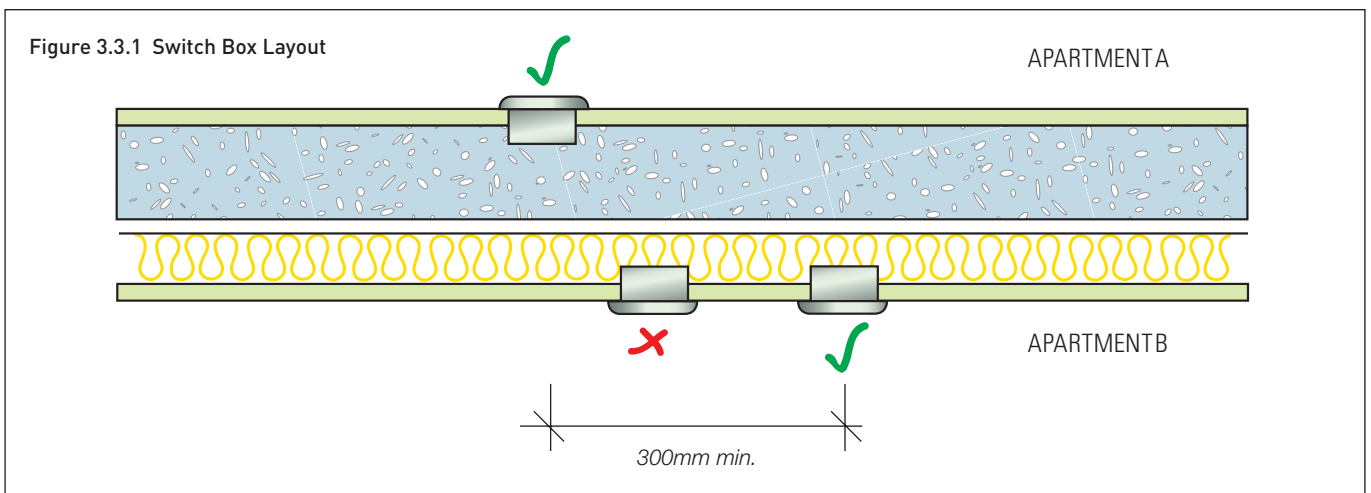

3.4 COATINGS

Typically in commercial applications, the surface finish of Hebel internal walls is determined according to project specifications and the intended use of the building. Hebel service shaft walls and scissor stair spine walls can be left in their manufactured finish or simply and inexpensively coated with a paint or textured paint.

If a coating is required, products such as Dulux Professional Total Prep may be used. Total Prep is a high quality, white or tintable 100% acrylic primer / sealer / undercoat

with excellent opacity, adhesion, flow, sealing and filling properties. It can be applied using airless / conventional spray or brush and roller. Refer to Dulux for more information and other paint finishes.

All substrate preparation and coating applications should be in accordance with the coating manufacturer's specification.

3.5 CONSTRUCTION DETAILS OVERVIEW



-  Hebel PowerPanel tongue & groove (T&G) H ≤ 3300mm
-  Hebel PowerPanel caged tongue & groove (T&G) vertical H ≤ 4650mm
-  Hebel PowerPanel caged tongue & groove (T&G) horizontal H ≤ 30mm

Table 3.5.1 Construction details overview

FRL up to -/90/90				
Head and base details	Head angle connection for panel heights ≤ 3300mm	Figure 3.6.1.1	Page 27	
	Head angle connection for panel heights > 3300mm	Figure 3.6.1.2	Page 27	
	Base angle connection for panel heights ≤ 3300mm	Figure 3.6.1.3	Page 27	
	Base angle connection for panel heights > 3300mm	Figure 3.6.1.4	Page 27	
	Alternate base angle connection for installation from one side only	Figure 3.6.1.5	Page 27	 
Vertical junction details: internal	Vertical edge with tongue & groove panel profile	Figure 3.6.2.1	Page 28	 
	Splay corner junction	Figure 3.6.2.2	Page 28	 
	Panel to column junction detail for panel heights > 3300mm & /or panel width < 300mm	Figure 3.6.2.3	Page 28	 
	Panel to panel junction detail	Figure 3.6.2.4	Page 28	 
	Hebel Intertency to Corridor wall junction	Figure 3.6.2.5	Page 28	 
	Offset panel to column for FRL -/60/60	Figure 3.6.2.6	Page 28	 
Vertical junction details: external	Hebel Intertency / Corridor Wall to Hebel Facade Wall junction (also SECTION AA)	Figure 3.6.3.1	Page 29	 
	Hebel Intertency / Corridor Wall to Hebel Facade Wall junction - SECTION AA	Figure 3.6.3.2	Page 29	 
	Hebel Intertency / Corridor Wall to brick veneer junction (also SECTION BB)	Figure 3.6.3.3	Page 29	 
	Hebel Intertency / Corridor Wall to brick veneer junction - SECTION BB	Figure 3.6.3.4	Page 29	 
Door details	Door opening	Figure 3.6.4.1	Page 30	 
	Door nib detail for widths 150 - 300mm	Figure 3.6.4.2	Page 30	 
	Door opening, Door nib detail for widths 150 - 300mm and Large penetration - SECTION AA	Figure 3.6.4.3	Page 30	 
	Door nib detail for widths 150 - 300mm - SECTION BB	Figure 3.6.4.4	Page 30	 
	Apartment fire door	Figure 3.6.4.5	Page 30	 
Control joint (CJ) detail	Hebel Intertency / Corridor wall with fire-rated control joint	Figure 3.6.5.1	Page 31	 
Penetration and services details	Large penetration in wall	Figure 3.6.6.1	Page 31	 
	Metal pipe penetration	Figure 3.6.6.2	Page 31	 
	Power switch / outlet installation to panel side	Figure 3.6.6.3	Page 31	 
	Power switch / outlet installation to steel stud or furring channel	Figure 3.6.6.4	Page 31	 
	Cable installation within the cavity for switch / outlets located on both sides of wall	Figure 3.6.6.5	Page 32	 
	Fire damper penetration	Figure 3.6.6.6	Page 32	 
Hebel + PVC pipe + joint	Plastic pipe penetration with in-wall type fire collar	Figure 3.6.7.1	Page 32	 
	Plastic pipe penetration with wall mounted fire collar	Figure 3.6.7.2	Page 32	 
FRL up to -/120/120				
Vertical panel installation: head, base and side details	Vertical installation. Maximum wall height 4.65m	Figure 3.7.1.1	Page 33	
	Head connection	Figure 3.7.1.2	Page 33	
	Base connection	Figure 3.7.1.3	Page 33	
	Alternate base angle connection for installation from one side only	Figure 3.7.1.4	Page 33	
	Vertical edge connection	Figure 3.7.1.5	Page 33	
Horizontal panel installation: head, base and side details	Horizontal installation. Maximum wall height 30m	Figure 3.7.2.1	Page 34	
	Head angle connection	Figure 3.7.2.2	Page 34	
	Base angle connection	Figure 3.7.2.3	Page 34	
	Alternate base angle connection for installation from one side only	Figure 3.7.2.4	Page 34	
	Vertical edge connection	Figure 3.7.2.5	Page 34	
	Unlimited height connection for horizontal panel installation only	Figure 3.7.2.6	Page 34	
Vertical junction details	Tongue and groove junction for vertical or horizontal installation	Figure 3.7.3.1	Page 35	 
	Splay corner junction for vertical panel installation only	Figure 3.7.3.2	Page 35	
	Corner junction for vertical or horizontal installation	Figure 3.7.3.3	Page 35	 
	T-junction for vertical or horizontal installation	Figure 3.7.3.4	Page 35	 
	Large penetration in wall: option 1	Figure 3.7.3.5	Page 35	
	Large penetration in wall: option 2	Figure 3.7.3.6	Page 35	

Project specific requirements: please contact CSR Hebel for advice on any project specific designs not covered in this Design and Installation Guide.

3.6 CONSTRUCTION DETAILS: FRL UP TO -/90/90

- Hebel PowerPanel tongue & groove (T&G) H ≤ 3300mm
- Hebel PowerPanel caged tongue & groove (T&G) vertical H ≤ 4650mm

3.6.1 HEAD AND BASE DETAILS

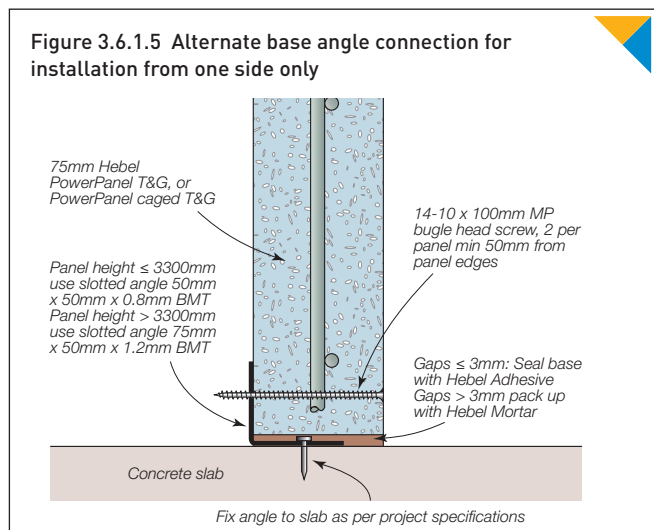
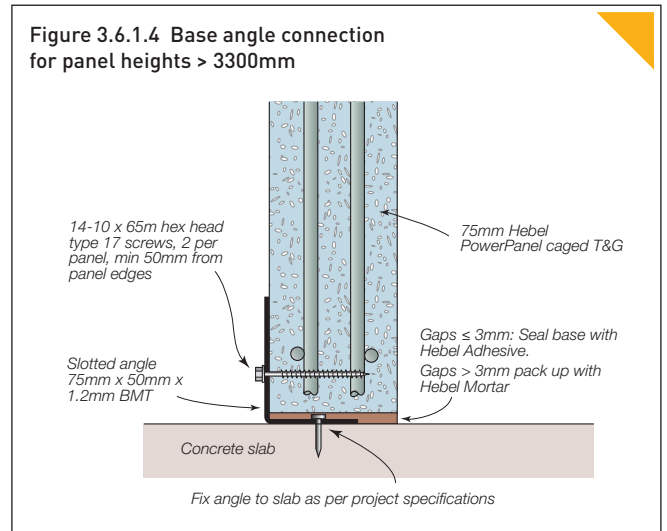
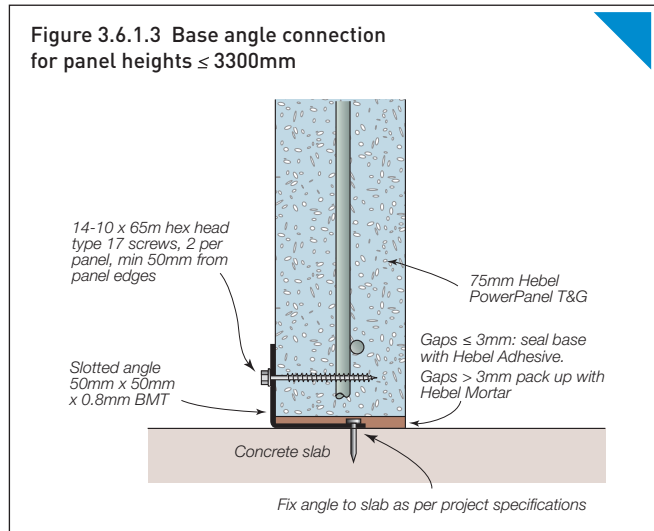
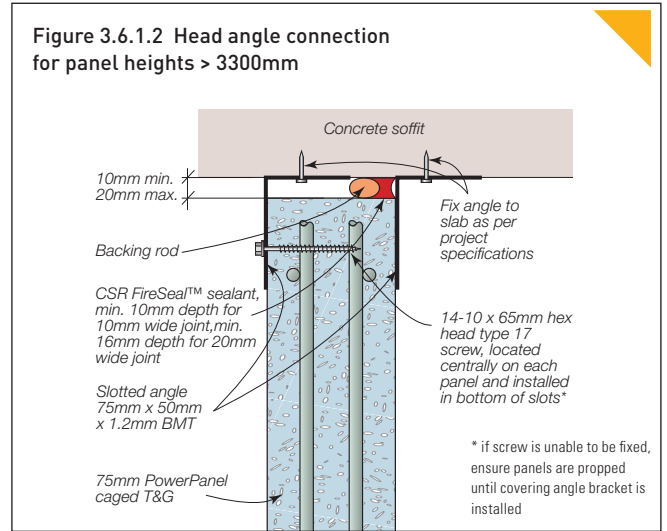
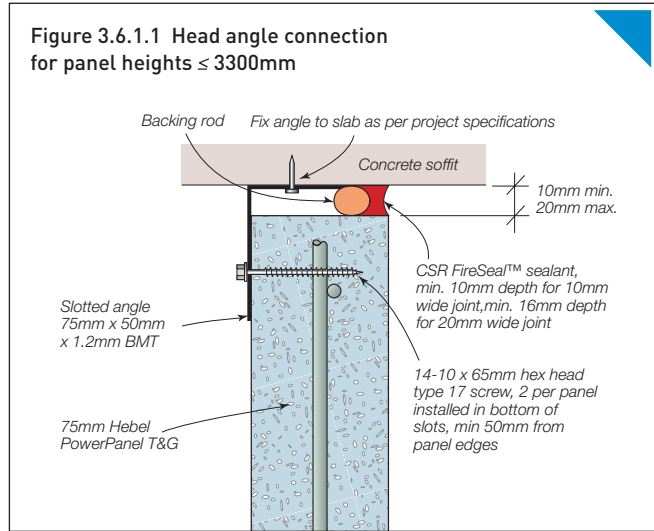

3.6.2 VERTICAL JUNCTION DETAILS: INTERNAL

Figure 3.6.2.1 Vertical edge with tongue & groove panel profile

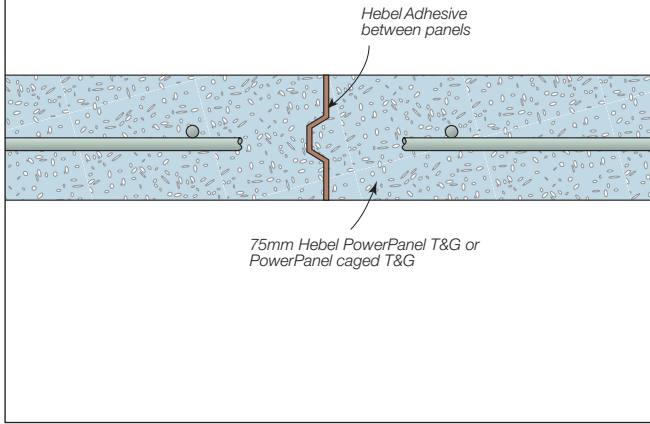

Figure 3.6.2.2 Splay corner junction

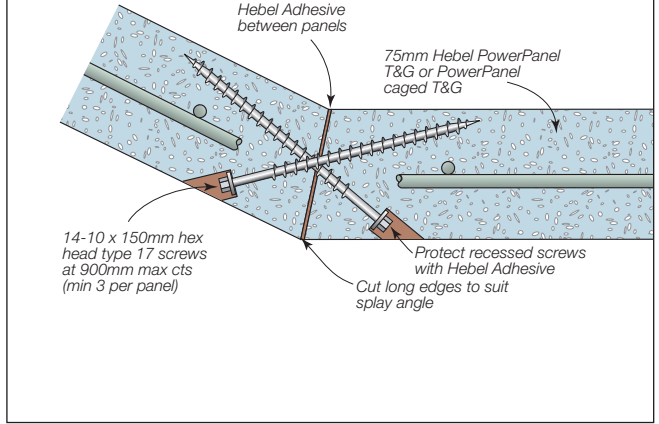

Figure 3.6.2.3 Panel to column junction detail for panels > 3300mm & / or panel width < 300mm

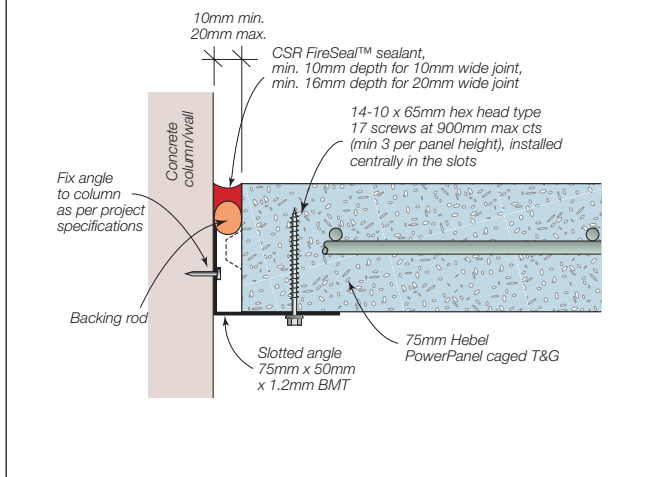

Figure 3.6.2.4 Panel to panel junction detail

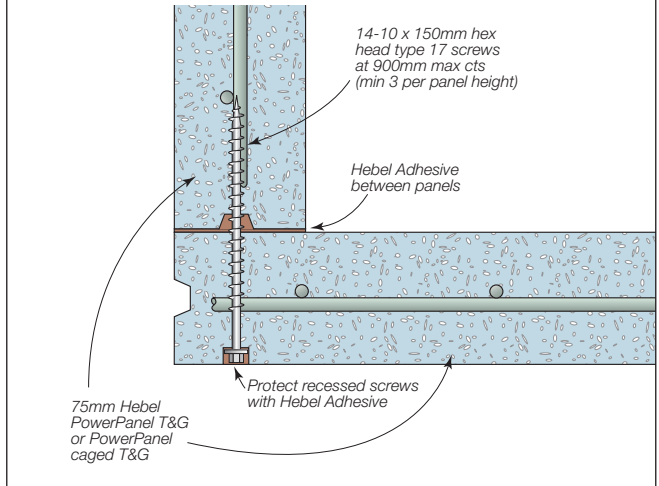

Figure 3.6.2.5 Hebel Intertency to Corridor wall junction

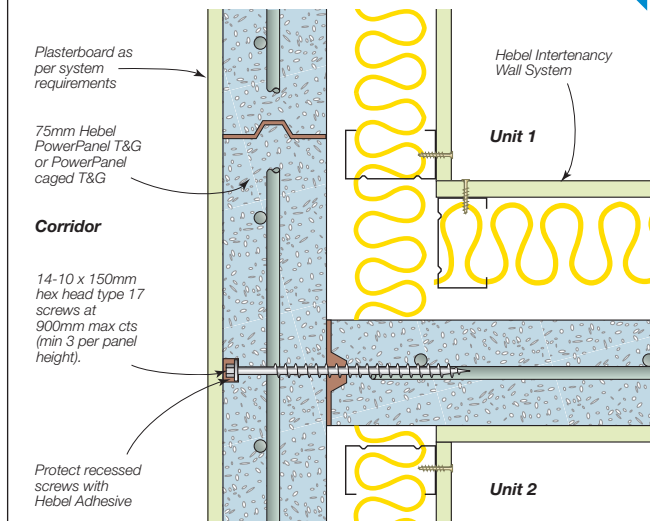
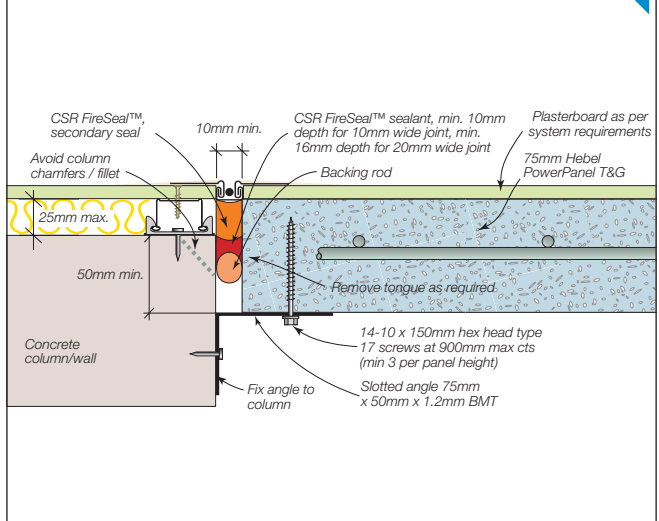

Figure 3.6.2.6 Offset panel to column for FRL -/60/60



3.6.3 VERTICAL JUNCTION DETAILS: EXTERNAL

Figure 3.6.3.1 Hebel Intertency / Corridor Wall to Hebel Facade Wall junction

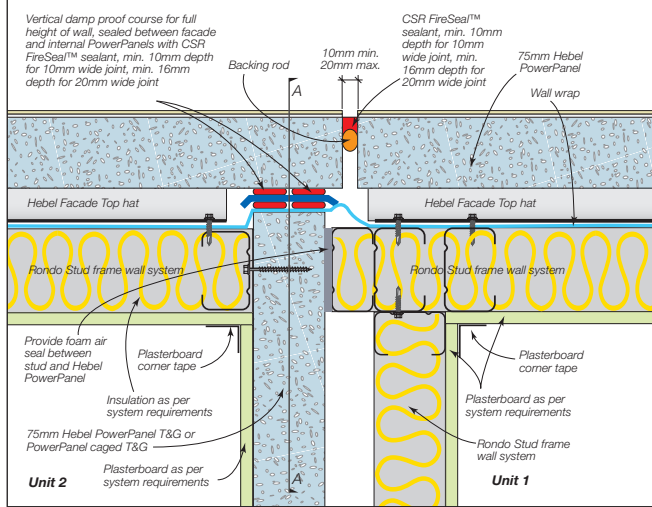

Figure 3.6.3.2 AA Hebel Intertency / Corridor Wall to Hebel Facade Wall junction - SECTION AA

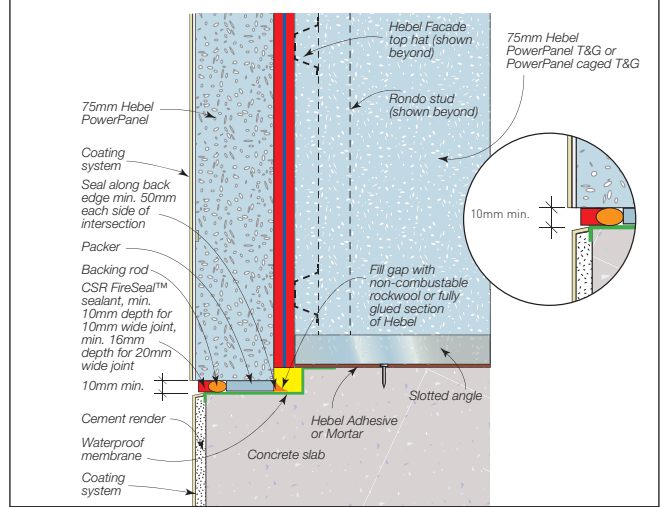

Figure 3.6.3.3 Hebel Intertency / Corridor Wall to brick veneer junction

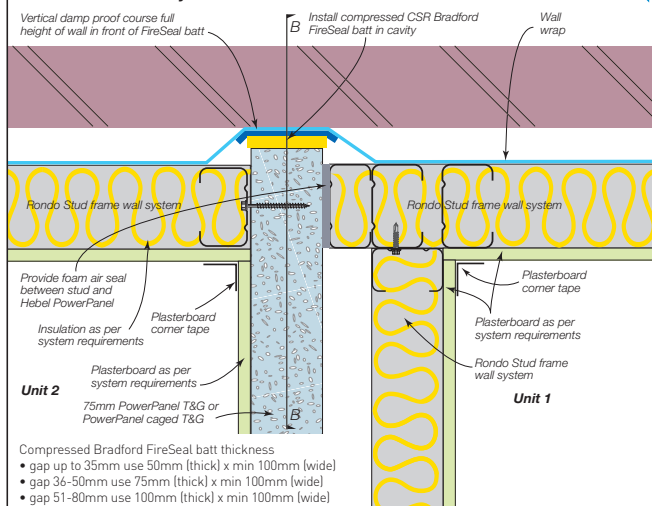
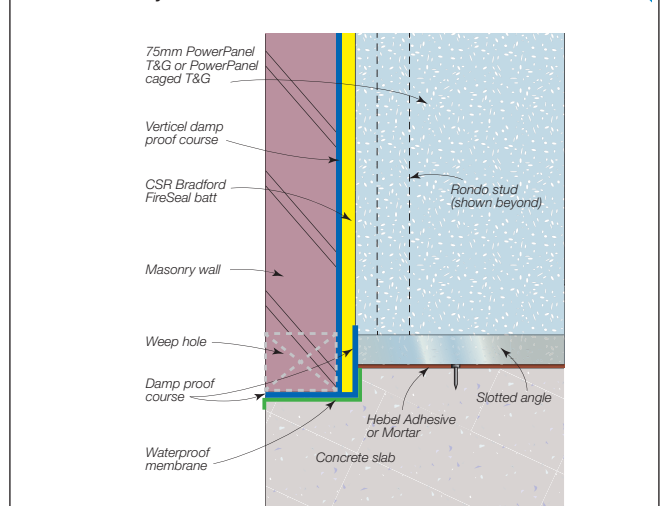
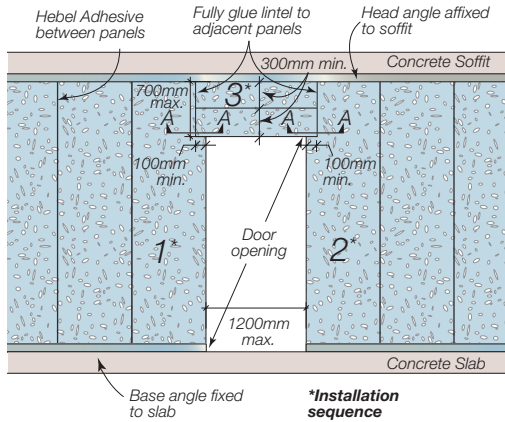

Figure 3.6.3.4 Hebel Intertency / Corridor Wall to brick veneer junction - SECTION BB



3.6.4 DOOR DETAILS

Figure 3.6.4.1 Door opening



***Installation sequence**
 Important:
 A. All door frame installations and detailing to be approved by door frame manufacturer.
 B. Continuously screw fix door frame to PowerPanel around perimeter of door opening.
 C. CSR Hebel recommends core filling of the door frame for additional robustness.
 D. Fix door frame at the base.

Figure 3.6.4.2 Door nib detail for widths 150 - 300mm

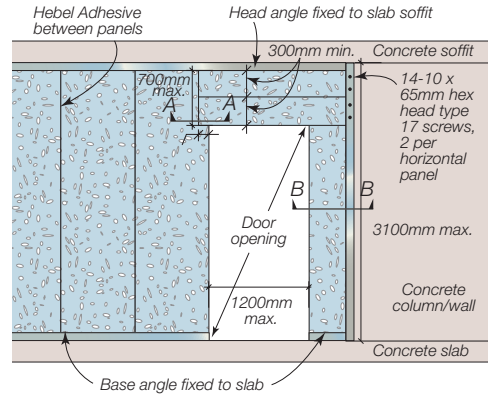
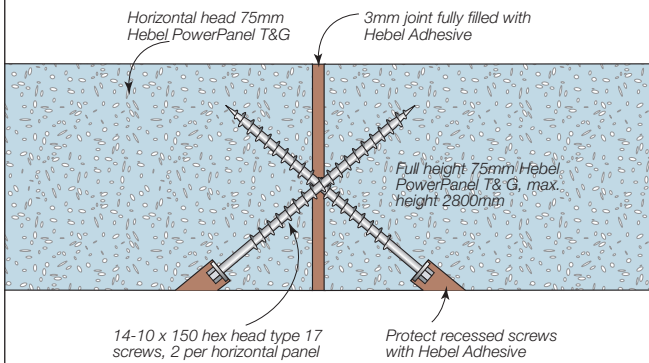

Figure 3.6.4.3 Door opening, Door nib detail for widths 150 - 300mm & Large penetration - SECTION AA



Note: screws can be omitted for FRL -/60/60 walls

Figure 3.6.4.4 Door nib detail for widths 150 - 300mm - SECTION BB

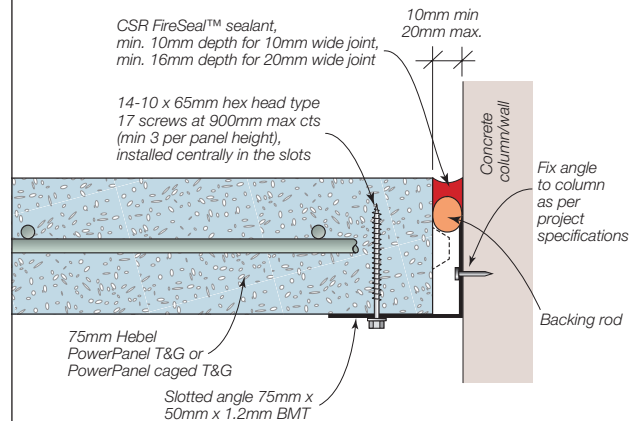
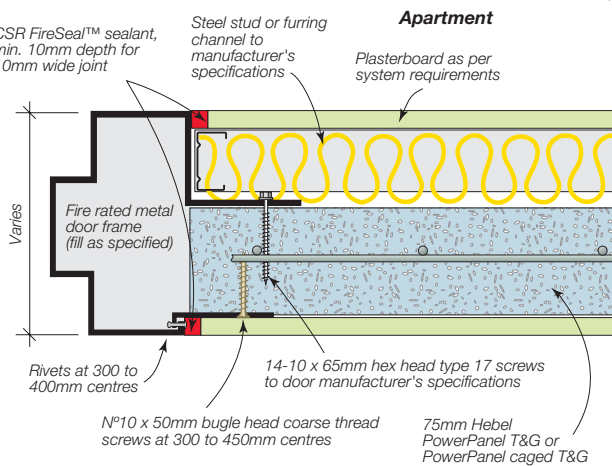

Figure 3.6.4.5 Apartment fire door



NOTE: All gaps between wall and frame to be filled with Tyco Fyreflex.

Figure 3.6.6.5 Cable installation within the cavity for switch / outlets located on both sides of wall

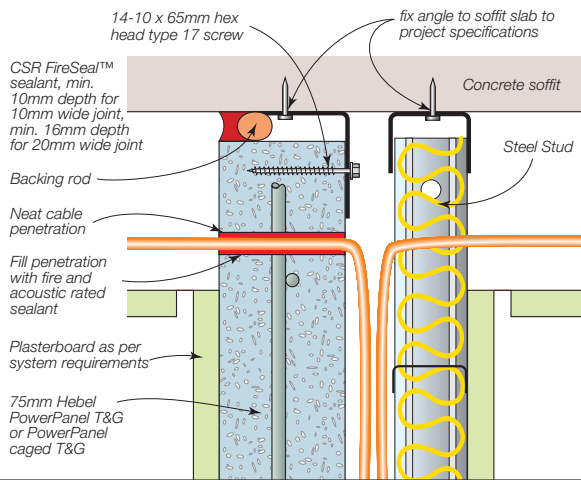
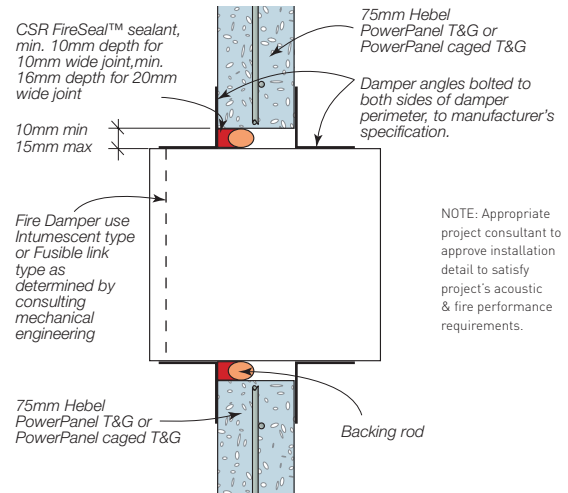

Figure 3.6.6.6 Fire damper penetration



3.6.7 HEBEL + PVC PIPE + JOINT

Figure 3.6.7.1 Plastic pipe penetration with in-wall type fire collar

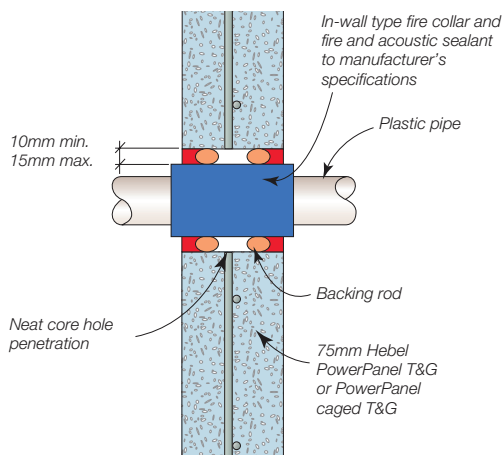
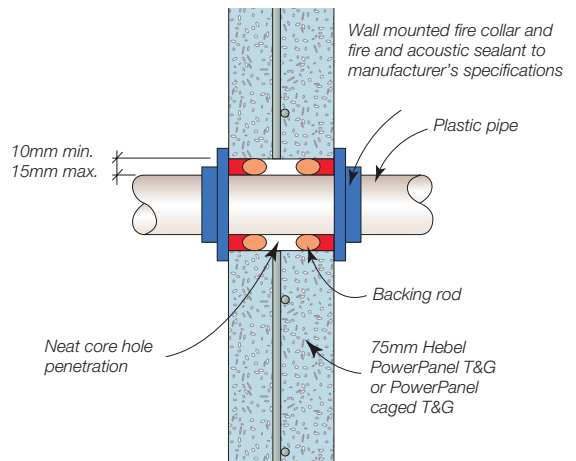

Figure 3.6.7.2 Plastic pipe penetration with wall mounted fire collar



3.7 CONSTRUCTION DETAILS: FRL UP TO -/120/120

Hebel PowerPanel caged tongue & groove (T&G) vertical H < 4650mm

3.7.1 VERTICAL PANEL INSTALLATION: HEAD, BASE AND SIDE DETAILS

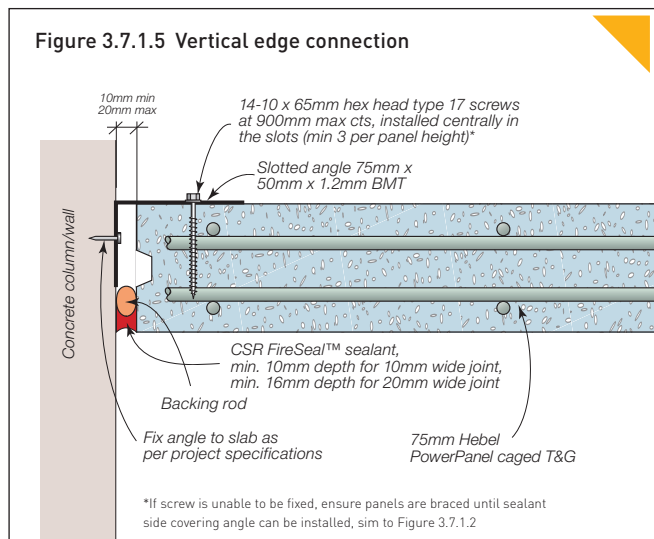
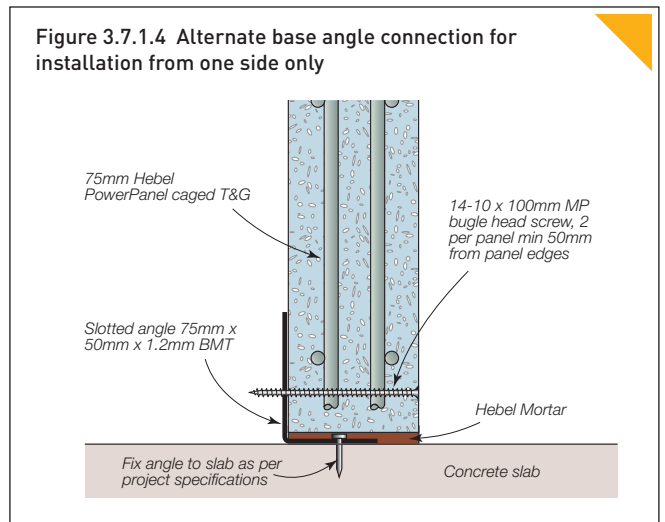
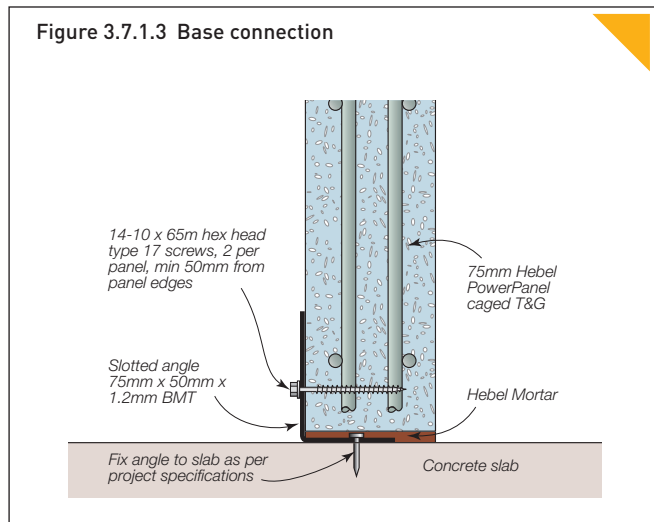
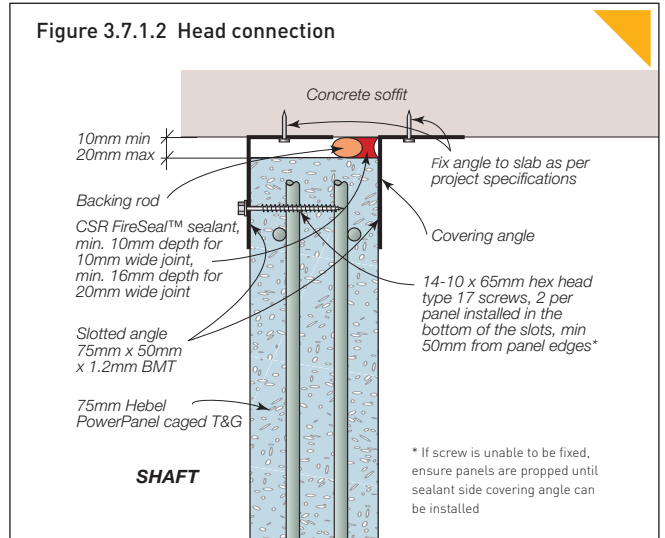
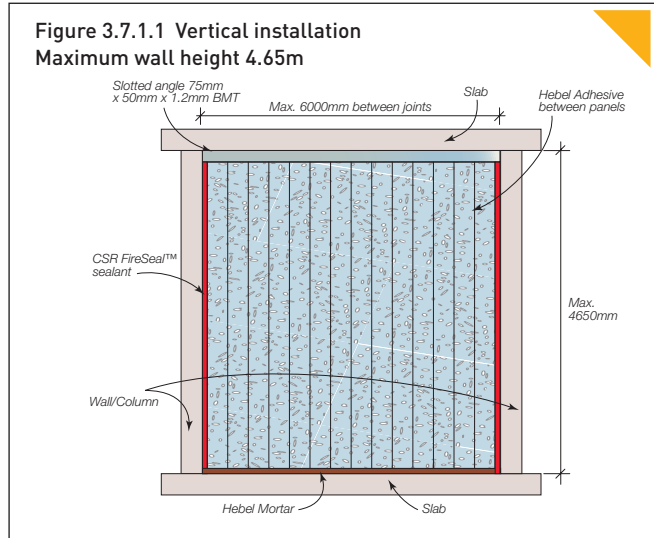

3.7.2 HORIZONTAL PANEL INSTALLATION: HEAD, BASE AND SIDE DETAILS

Figure 3.7.2.1 Horizontal installation maximum wall height 30m

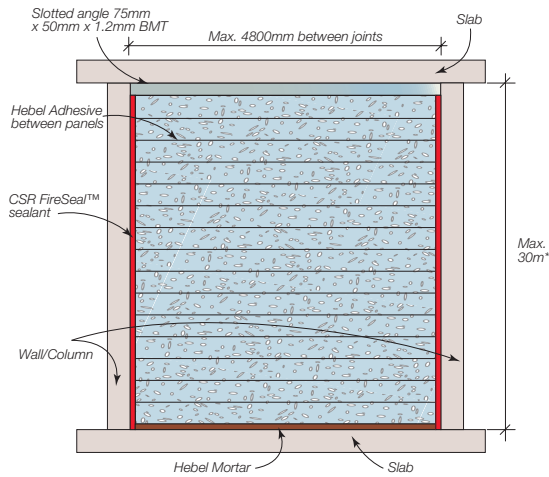

*See Figure 3.7.2.6 for unlimited height detail

Figure 3.7.2.2 Head angle connection

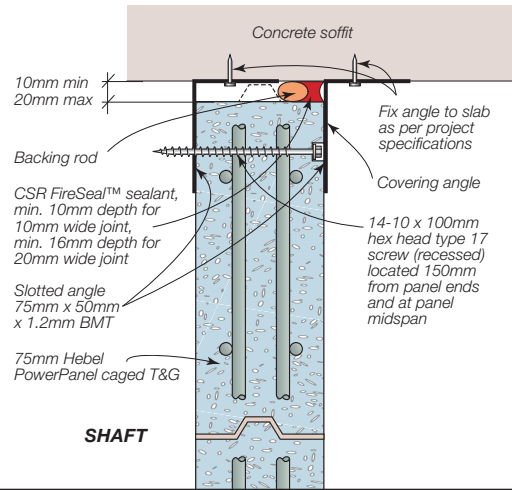

Figure 3.7.2.3 Base angle connection

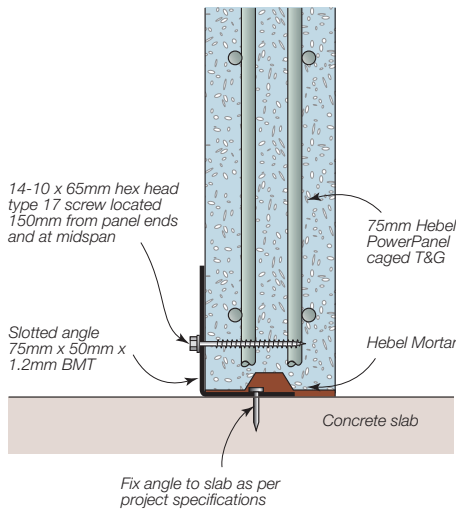

Figure 3.7.2.4 Alternate base angle connection for installation from one side only

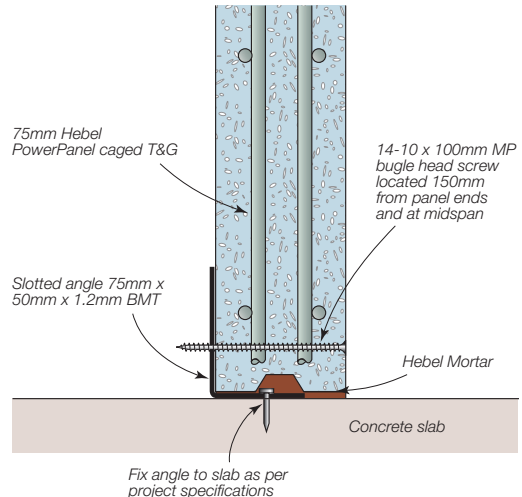
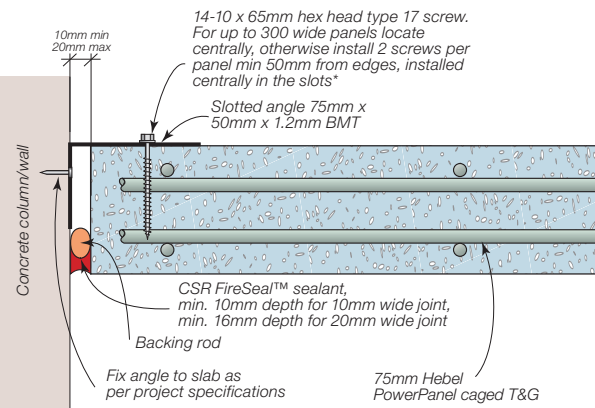
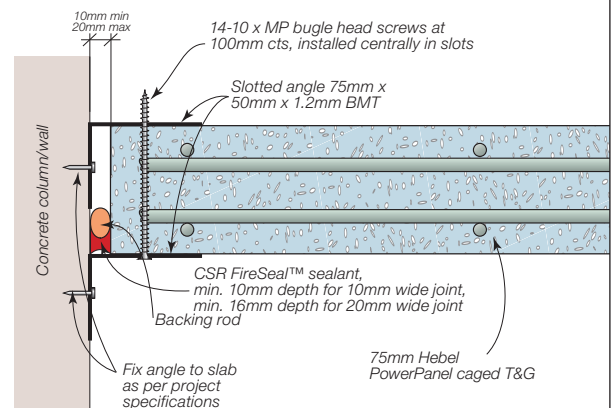

Figure 3.7.2.5 Vertical edge connection



*If screw is unable to be fixed, ensure panels are braced until sealant side covering angle can be installed, sim to Figure 3.7.2.2

Figure 3.7.2.6 Unlimited height connection for horizontal panel installation only



3.7.3 VERTICAL JUNCTION DETAILS

Figure 3.7.3.1 Tongue and groove junction for vertical or horizontal installation

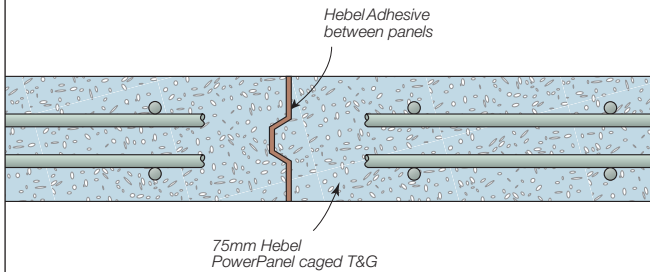

Figure 3.7.3.2 Splay corner junction for vertical panel installation only

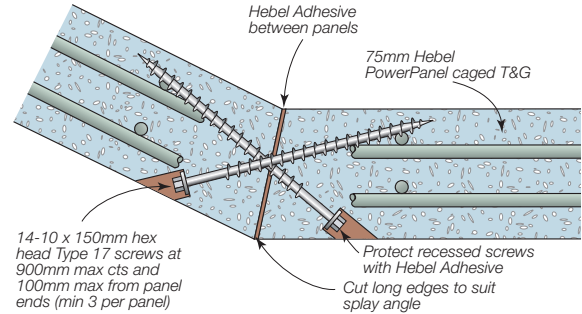

Figure 3.7.3.3 Corner junction for vertical or horizontal installation

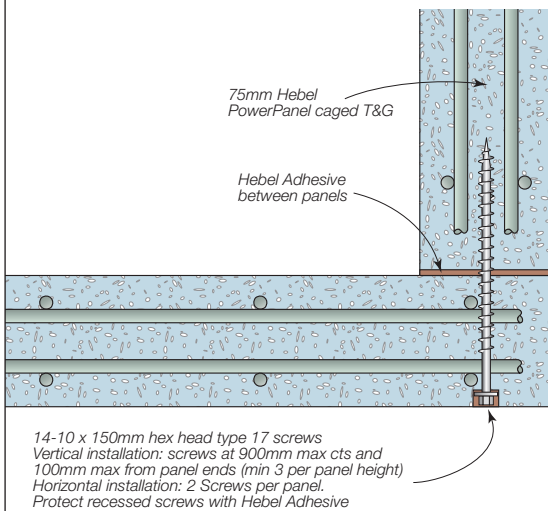

Figure 3.7.3.4 T-junction for vertical or horizontal installation

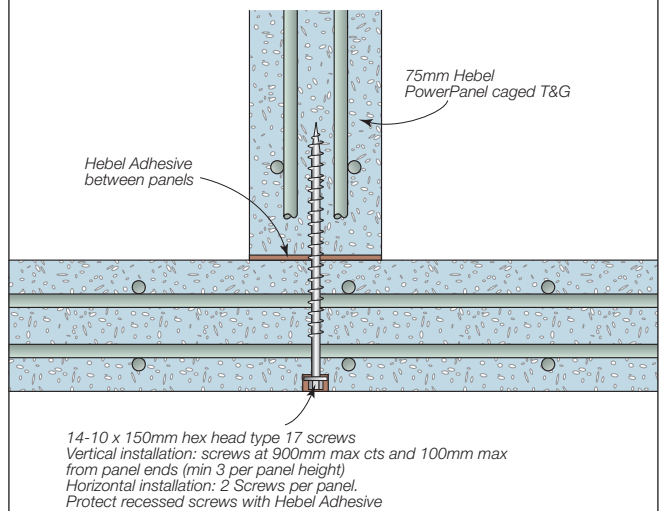

Figure 3.7.3.5 Large penetration in wall: option 1

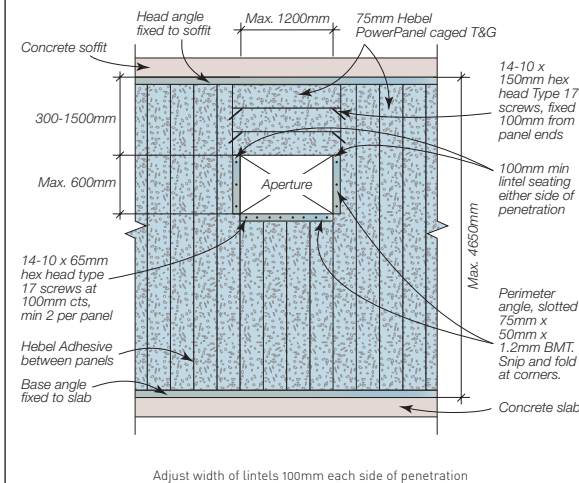
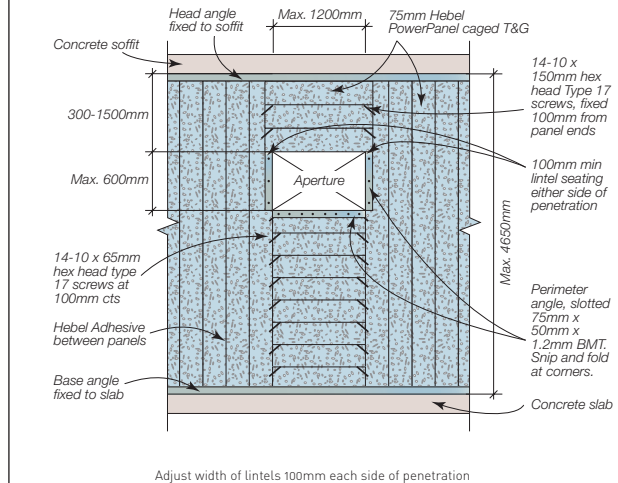

Figure 3.7.3.6 Large penetration in wall: option 2



4.1 DELIVERY AND STORAGE

UNLOADING PANELS

Panels must be unloaded and moved with only approved lifting devices. Before use, the lifting devices should be checked for the required lifting tags. Panels should be unloaded as close as possible to the intended installation area. This will increase work efficiency and minimise the need for secondary lifting.

STORAGE

All materials should be kept dry and preferably stored undercover. Care should be taken to avoid sagging or damage to ends, edges and surfaces.

All Hebel products must be stacked on edge and properly supported off the ground, on a level platform. Panel bundles can be stacked two high.

The project engineer should be consulted as to the adequacy of the structure to support the stacked bundles. Each bundle contains ten PowerPanels. Where bundles are stacked two high the supporting cleats must be vertically aligned to ensure minimal bending of the lower panels. (see Figure 4.1.1). If Hebel PowerPanels are stored outside they must be stored off the ground and protected from the weather.

To provide a level surface we recommend placing temporary joists beneath the supporting cleats.

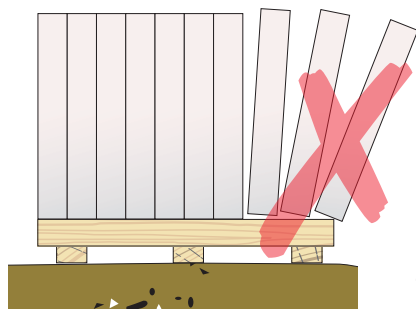

Unstrapping bundles without appropriate bracing.

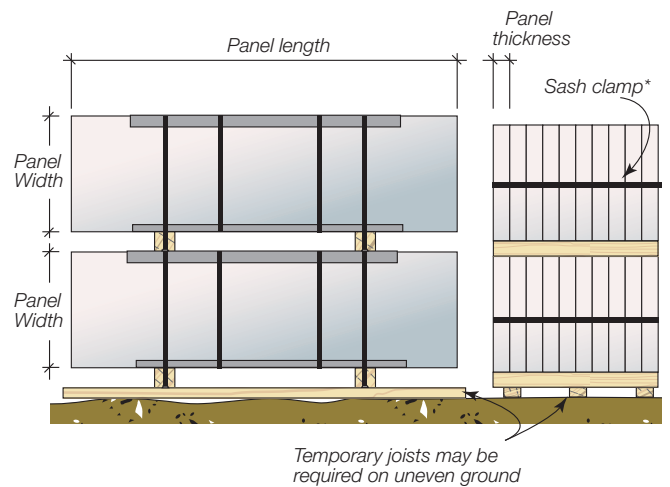

Figure 4.1.1 Stacking bundles of Hebel PowerPanel

Note: Secondary handling increases the risk of panel damage. The repair of damage sustained during lifting and moving is the responsibility of the lifter. Where damage is excessive, panels must be replaced.

4.2 PANEL HANDLING

MANUAL HANDLING

Hebel recommends using a trolley or other mechanical apparatus to move the panels around the work site. Manual handling where people physically move a panel should be kept to a minimum, with the weight being supported by an individual kept as small as possible. Any concerns regarding the weight to be handled should be discussed with the panel installation contractor.

To minimise the possibility of manual handling injuries Hebel suggests the following:

- use mechanical aids such as trolleys, forklifts, lifters, cranes and levers, or team lifting to move panels
- keep the work place clean to reduce the risk of slips, trips and falls, which can cause injury
- plan the sequence of installation to minimise panel movements and avoid awkward lifts
- train employees in good lifting techniques to minimise the risk of injury.

Figure 4.2.1 Hebel Panel Lifters are used for positioning panel in wall.



TROLLEY ASSISTED HANDLING

Hebel has developed a trolley to allow easier and safer handling of Hebel PowerPanel onsite. There is a range of trolleys to suit panels from 1.2m to 4.2m in length.

HEALTH AND SAFETY

Hebel products are cement-based which may irritate the skin resulting in itching and occasionally a red rash. The wearing of gloves and suitable clothing to reduce abrasion and irritation of the skin is recommended when handling Hebel products.

Approved respirators (AS/NZS1715 and AS/NZ1716) and eye protection (AS1336) should be worn at all times when cutting and chasing. Refer to the Hebel Material Safety Data Sheets.

Refer to the back page of this Design and Installation Guide for further information regarding health and safety.

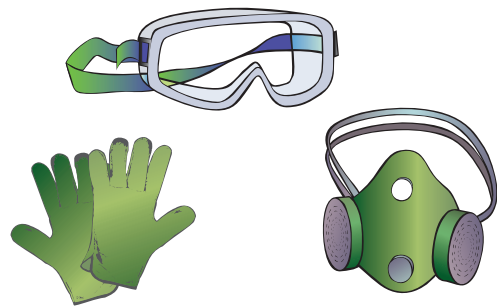

Figure 4.2.3 Standard personal protection equipment (PPE).



Figure 4.2.2 Hebel Panel Trolleys for easier and safer handling and cutting of Hebel PowerPanels.

4.3 DESIGN, DETAILING AND PERFORMANCE RESPONSIBILITIES

Hebel engages independent acoustic testing laboratories to test and report on the acoustic performance of a wall in accordance with the relevant Australian Standards. Acoustic consultants use these reports as the basis for opinions (estimates of laboratory performance) they issue for variations or different arrangements to the tested system, and also to design and specify walls that meet appropriate criteria for a particular project. Using their experience, the acoustic consultant will make judgements about onsite installed performance of various walls. The performance levels of walls documented in this Design and Installation Guide are either what is reported in a test or the documented opinion of an acoustic consultant.

Responsibility for acoustic performance in projects is typically:

PROJECT ACOUSTIC CONSULTANT:

- Opinions on expected laboratory performance of wall configurations that vary from actual test configuration such as substitution products and components.
- Judgements about expected field performance using laboratory test reports and practical experience.
- Design, specification and certification of acoustic performance for individual projects. This involves the design and selection of building elements, such as walls and floors and their integration in the building considering the following:
 - Interface of different building elements and to the structure/substrate
 - Wall junctions
 - Penetrations
 - Flanking issues
 - Room/building geometry
 - Acoustic field testing

PROJECT CERTIFIER &/OR BUILDER:

- Identifying the acoustic performance requirements for the project in accordance with the National Construction Code (NCC) and clearly communicating this to relevant parties.
- Applicability of any acoustic information supplied by CSR Hebel including tests and opinions for the project.
- The project acoustic consultant's responsibilities detailed above if one is not engaged in the project.

CSR Hebel does not provide acoustic consulting services and does not offer acoustic advice. CSR Hebel only provides information that has been prepared by others and CSR Hebel therefore shall not be considered experts in the field. Any party using the information contained in this Design and Installation Guide or supplied by CSR Hebel in the course of a project must satisfy themselves that it is true, accurate and appropriate for the application, consequently accepting responsibility for its use. CSR Hebel is not responsible for the acoustic performance of constructed walls, including field performance, and does not interpret or make judgements about acoustic performance requirements in the National Construction Code (NCC).

The above is applicable to other design criteria such as fire and structure.

5.1 APPENDIX 1

HEBEL POWERPANEL MATERIAL PROPERTIES

PowerPanel physical properties

1. Nominal dimensions and profiles of standard and custom Hebel PowerPanel are shown in Section 1.11.
2. Standard Hebel PowerPanel has a single layer of steel reinforcement consisting of 4 longitudinal bars of 5mm diameter.
3. Custom Hebel PowerPanel has a single or double layer of steel reinforcement consisting of 4 or 5 longitudinal bars of 5mm diameter.
4. Nominal dry density = 510kg/m³.
5. Average working density = 663kg/m³ at 30% moisture content.
6. Average service life density = 561kg/m³ at 10% moisture content.
7. For custom PowerPanel average working density = 707kg/m³ at 30% moisture content.

PowerPanel strength properties

1. Characteristic compressive strength, $f'_m = 2.8$ MPa.
2. Average compressive strength = 3.2 MPa.
3. Characteristic Modulus of Rupture, $f' = 0.60$ MPa.

PowerPanel fire rating properties

For FRL ratings of Hebel PowerPanel internal walls refer to fire opinions: 26095-13 and 27915-13 and Fire Test Report FSV-0979.

PowerPanel acoustic properties

Hebel PowerPanel with no plasterboard or other lining $R_w = 36$ dB (refer to ATF-676 test and PKA-201006C02 opinion).

PowerPanel thermal properties

R-Value of Hebel PowerPanel with no plasterboard or other lining = 0.375m²K/W at 14% moisture content.

A2 TERMINOLOGY AND ASSESSMENT METHODS

Weighted Sound Reduction Index (R_w)

Australian building regulations have adopted the European acoustic rating system, the 'Weighted Sound Reduction Index' (R_w), which is the International Standard. The R_w value replaces the former 'Sound Transmission Class' (STC) as a measure of the acoustic performance of a wall.

C_{tr} Adaptation Term

The R_w provides a convenient single number performance rating for 'normal' sounds such as speech. Where low frequency sound insulation performance is important, as may be the case with traffic noise or music and DVD systems, a correction factor is added to the R_w number. This factor de-rates the wall system's performance according to its ability to insulate low frequency sound. The factor is called C_{tr} and it is a negative value. Therefore, a wall having an R_w of 55dB with a C_{tr} of -5dB has an $R_w + C_{tr}$ rating of 50dB.

Impact Sound Transfer

Impact sound is caused by vibrations, which are transferred directly through the wall and re-radiated as sound in the adjacent room. These sound vibrations can be generated by actions such as closing of a cupboard door.

The transfer of impact sound can be minimised by ensuring no mechanical connection exists between the two sides of the wall. For impact rated walls the BCA requires walls to be of 'discontinuous construction'. This refers to a wall maintaining a minimum 20mm cavity between two separate leaves except at the periphery.

Test reports

All acoustic test reports have been issued by the National Acoustic Laboratory or other NATA Registered Laboratories. All fire test reports have been issued by CSIRO. Test reports quoted in this Design and Installation Guide are available on request from CSR Hebel.

Sound insulation estimates

Acoustic consultants often use computer models to determine sound transmission estimates for specific wall system configurations. These are known as 'Acoustic Assessments' or 'Acoustic Opinions'.

The computer model predicts the R_w performance expected from a laboratory test on the system. All acoustic opinions quoted in this Design Guide are available on request from CSR Hebel.

Fire Resistance Level (FRL) index

The Fire Resistance Level (FRL) of the systems detailed in this Design and Installation Guide have been determined from CSIRO, Exova and BRANZ fire opinions based on testing conducted at the CSIRO laboratories in North Ryde.

The FRL rating consists of three performance criteria, structural adequacy / integrity / insulation. For non-load bearing walls, there is no requirement for 'structural adequacy' rating. For example, the FRL of a non-load bearing wall may be expressed as -/120/90 where the 'dash' indicates no rating for a 'structural adequacy' rating, followed by 'integrity' for 120 minutes and 'insulation' for 90 minutes.

These tests and opinions refer to a range of wall heights. Please refer to FRL values for the selected systems in this Design and Installation Guide.

Acoustic and fire tests

All tests performed on CSR Hebel walls have been done in accordance with relevant Australian Standards at the time of testing.



CSR HEBEL
Trinity 3, 39 Delhi Road
North Ryde NSW 2113, Australia
Telephone +61 2 9235 8000

Health & safety

Information on any known health risks of our products and how to handle them safely is on product packaging and / or the accompanying documentation. Additional information is listed in the Material Safety Data Sheet (MSDS). To obtain a copy of a MSDS, download from www.hebel.com.au. Contractors are required by law to perform their own risk assessments before undertaking work.

Performance & certification

Hebel® products and systems are developed in Australia by CSR Building Products. ABN. 55 008 631 356. It is a manufacturer and supplier of Hebel Autoclaved Aerated Concrete (AAC) products. Because it is a manufacturer and supplier only, CSR does not employ people qualified as Accredited or Principal Certifiers.

CSR is therefore unable to provide Construction Compliance Certificates or Statements of Compliance. CSR conducts appropriate testing of its products and systems to determine performance levels. These include structural, fire and acoustic tests. Testing is conducted and certified by appropriate specialists in these fields. When using Hebel products and systems in specific projects, such specialists should be consulted to ensure compliance with the Building Code of Australia and relevant Australian Standards.

Disclaimer

Information presented in this document is supplied in good faith and to the best of our knowledge was accurate at the time of preparation. The provision of this information should not be construed as a recommendation to use any of our products in violation of any patent rights or in breach of any statute or regulation. Users are advised to make their own determination as to the suitability of this information in relation to their particular purpose or specific circumstances. Since the information contained in this document may be applied under conditions beyond our control, no responsibility can be accepted by CSR, or its staff for any loss or damage caused by any person acting or refraining from action as a result of misuse of this information.

Other

The design of a wall, floor or fence system requires the services of professional consultants. This document has been prepared as a source of information to provide general guidance to those consultants – and in no way replaces the services of the professional consultant and relevant engineers designing the project.

No liability can therefore be accepted by CSR or other parties for the use of this document. Hebel products and systems undergo constant research and development to integrate new technology and reflect ongoing performance enhancement.

Hebel systems are constantly reviewed so as to reflect any changes in legislative building requirements and or general developments in common building practice, due to our commitment to continual development and improving our building systems.

We advise that all users of this document should regularly check that this document is current, and they are applying our latest design information.

The latest editions of our documents are available on our website:

www.hebel.com.au

Hebel® is a registered trademark of the Xella group. CSR Building Products Ltd is an exclusive licensee of Xella. CSR Hebel is a business of CSR Building Products Ltd ABN 55 008 631 356.

CSR, PowerPanel®, PowerClad®, Hebel Block®, PowerFloor®, Hebel Floor®, PowerFence®, HighBuild®, are registered trademarks of CSR Building Products Limited.

THE BETTER WAY TO BUILD

Hebel is a quality building product, and is backed by CSR Building Products Limited.

For more information visit our website:

www.hebel.com.au

For sales enquiries or further information, please telephone us from anywhere in Australia:

1300 369 448

